



Dell V310 Series User's Guide

April 2009

www.dell.com | support.dell.com

Machine type(s):

4443

Model(s):

1d1, 1dw, 5dw

Trademarks

Information in this document is subject to change without notice.

Reproduction in any manner whatsoever without the written permission of Dell Inc. is strictly forbidden. Trademarks used in this text: *Dell* and the *DELL* logo are trademarks of Dell Inc.; *Microsoft* and *Windows* are registered trademarks of Microsoft Corporation. Other trademarks and trade names may be used in this document to refer to the entities claiming the marks and names of their products. Dell Inc. disclaims any proprietary interest in trademarks and trade names other than its own.

Contents

Safety information	7
About your printer	8
Thank you for choosing this printer!.....	8
Minimizing your printer's environmental impact.....	8
Finding information about the printer.....	9
Understanding the parts of the printer.....	11
Ordering and replacing supplies	13
Replacing ink cartridges.....	13
Ordering ink cartridges.....	14
Recycling Dell products.....	15
Using the printer control panel buttons and menus	16
Using the printer control panel.....	16
Using the printer menus.....	18
Changing temporary settings into new default settings.....	19
Changing the Power Saver timeout.....	20
Resetting to factory settings.....	21
Saving energy with Eco-Mode.....	21
Using the printer software	23
Minimum system requirements.....	23
Using the Windows printer software.....	23
Updating the printer software (Windows only).....	25
Reinstalling the printer software.....	25
Loading paper and original documents	26
Loading paper.....	26
Saving paper default settings.....	28
Loading original documents on the scanner glass.....	29
Printing	30
Tips for printing.....	30
Printing basic documents.....	30

Printing specialty documents.....	32
Printing on both sides of the paper (duplexing) manually.....	33
Working with photos.....	35
Printing from a Bluetooth-enabled device.....	40
Managing print jobs.....	43
Copying.....	45
Tips for copying.....	45
Making copies.....	45
Copying photos.....	46
Enlarging or reducing images.....	46
Adjusting copy quality.....	46
Making a copy lighter or darker.....	47
Collating copies using the printer control panel.....	47
Repeating an image on one page.....	48
Copying multiple pages on one sheet.....	48
Making a duplex copy manually.....	48
Canceling copy jobs.....	49
Scanning.....	50
Tips for scanning.....	50
Scanning to a local or network computer.....	50
Scanning to a flash drive or memory card.....	51
Scanning photos into an editing application.....	51
Scanning documents into an editing application.....	52
Scanning directly to e-mail.....	53
Scanning to a PDF.....	53
Scanning FAQ.....	53
Canceling scan jobs.....	54
Networking.....	55
Installing the printer on a wireless network.....	55
Advanced wireless setup.....	59
Networking FAQ.....	63
Maintaining the printer.....	73
Maintaining ink cartridges.....	73

Cleaning the exterior of the printer.....	74
Cleaning the scanner glass.....	75
Troubleshooting.....	76
Before you troubleshoot.....	76
Using the Service Center to solve printer problems.....	76
If Troubleshooting does not solve your problem.....	76
Setup troubleshooting.....	76
Jams and misfeeds troubleshooting.....	81
Print troubleshooting.....	83
Copy and scan troubleshooting.....	84
Memory card troubleshooting.....	86
Wireless troubleshooting.....	88
Index.....	103

Safety information

Connect the power cord to an electrical outlet that is near the product and easily accessible.

Do not place or use this product near water or wet locations.

Use only the power supply and power cord provided with this product or the manufacturer's authorized replacements.

This product is designed, tested, and approved to meet strict global safety standards with the use of specific manufacturer's components. The safety features of some parts may not always be obvious. The manufacturer is not responsible for the use of other replacement parts.

 **CAUTION—POTENTIAL INJURY:** Do not cut, twist, bind, crush, or place heavy objects on the power cord. Do not subject the power cord to abrasion or stress. Do not pinch the power cord between objects such as furniture and walls. If any of these things happen, a risk of fire or electrical shock results. Inspect the power cord regularly for signs of such problems. Remove the power cord from the electrical outlet before inspecting it.

Refer service or repairs, other than those described in the user documentation, to a professional service person.

 **CAUTION—SHOCK HAZARD:** To avoid the risk of electric shock when cleaning the exterior of the printer, unplug the power cord from the wall outlet and disconnect all cables from the printer before proceeding.

 **CAUTION—SHOCK HAZARD:** Do not use the fax feature during a lightning storm. Do not set up this product or make any electrical or cabling connections, such as the fax feature, power cord, or telephone, during a lightning storm.

SAVE THESE INSTRUCTIONS.

About your printer

Thank you for choosing this printer!

We've worked hard to make sure it will meet your needs.

To start using your new printer right away, use the setup materials that came with the printer, and then skim the *User's Guide* to learn how to perform basic tasks. To get the most out of your printer, read the *User's Guide* carefully, and make sure you check the latest updates on our Web site.

We're committed to delivering performance and value with our printers, and we want to make sure you're satisfied. If you do encounter any problems along the way, one of our knowledgeable support representatives will be delighted to help you get back on track fast. And if you find something we could do better, please let us know. After all, you are the reason we do what we do, and your suggestions help us do it better.

Minimizing your printer's environmental impact

We are committed to protecting the environment and are continually improving our printers to reduce their environmental impact. By selecting certain printer settings or tasks, you may be able to reduce your printer's environmental impact even further.

Conserving energy

- **Eco-Mode.** This feature sets the screen brightness to low and sets the printer to change to Power Saver mode after the printer is left idle for 10 minutes. Eco-Mode is enabled by default in your printer.
- **Select the lowest Power Saver timeout.** The Power Saver feature puts the printer in a minimum-power standby mode after the printer has been idle for a set amount of time (the Power Saver timeout).
- **Share your printer.** Wireless/network printers allow you to share a single printer among multiple computers, thus conserving energy and other resources.

Conserving paper

- **Print more than one page image on one side of the paper.** The "Pages per sheet" feature allows you to print multiple pages on one sheet. You can print up to 8 page images on one side of a sheet of paper.
- **Print on both sides of the paper.** Duplexing lets you print on both sides of the paper manually or automatically (depending on your printer model).
- **Preview print jobs before printing.** Use the preview features found in the Print Preview dialog or the printer display (depending on your printer model).
- **Scan and save.** To avoid printing multiple copies, you can scan documents or photographs and save them to a computer program, application, or flash drive for presentation.
- **Use recycled paper.**

Conserving ink

- **Use Quick Print or Draft Mode.** These modes can be used to print documents using less ink than normal and are ideal for printing documents that are mostly text.
- **Use High Yield cartridges.** Inks in High-Yield cartridges allow you to print more pages with fewer cartridges.

- **Clean the printhead.** Before replacing and recycling your ink cartridges, try using the “Clean Printhead” and “Deep Clean Printhead” features. These features clean the printhead nozzles to improve the quality of your prints.

Recycling

- **Return empty ink cartridges for reuse or recycling through the Dell Cartridge Collection Program.** To return an empty ink cartridge, go to www.dell.com/recycling to request a postage-paid bag.
- **Recycle the product packaging.**
- **Recycle your old printer instead of throwing it away.**
- **Recycle paper from discarded print jobs.**
- **Use recycled paper.**

Finding information about the printer

Publications

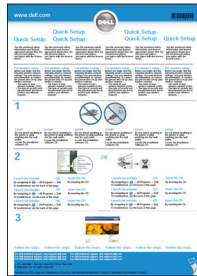
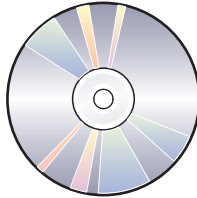
What are you looking for?	Find it here
<p>Initial setup instructions:</p> <ul style="list-style-type: none"> • Connecting the printer • Installing the printer software 	<p>Setup documentation The setup documentation came with the printer.</p> 
<p>Additional setup and instructions for using the printer:</p> <ul style="list-style-type: none"> • Selecting and storing paper and specialty media • Loading paper • Performing printing, copying, scanning, and faxing tasks, depending on your printer model • Configuring printer settings • Viewing and printing documents and photos • Setting up and using printer software • Setting up and configuring the printer on a network, depending on your printer model • Caring for and maintaining the printer • Troubleshooting and solving problems 	<p><i>User's Guide</i> The <i>User's Guide</i> is available on the installation software CD.</p>  <p>For updates, check our Web site at support.dell.com.</p>

What are you looking for?	Find it here
<p>Help using the printer software</p>	<p>Windows Help</p> <p>Open a printer software program or application, and then click Help.</p> <p>Click  to view context-sensitive information.</p> <p>Notes:</p> <ul style="list-style-type: none"> • The Help installs automatically with the printer software. • The printer software is located in the printer Program folder or on the desktop, depending on your operating system.
<p>The latest supplemental information, updates, and online technical support:</p> <ul style="list-style-type: none"> • Troubleshooting hints and tips • Frequently asked questions • Documentation • Driver downloads • Live chat support • E-mail support • Telephone support 	<p>Dell Support Web site—support.dell.com</p> <p>Note: Select your region, and then select your product to view the appropriate support site.</p> <p>Support telephone numbers and hours of operation for your region or country can be found on the Support Web site.</p> <p>Have the following information ready when you contact support so that they may serve you faster:</p> <ul style="list-style-type: none"> • Service Tag • Express Service Code <p>Note: The Service Tag and Express Service Code appear on labels located on your printer.</p>
<ul style="list-style-type: none"> • Software and Drivers—Certified drivers for your printer and installers for Dell printer software • Readme files—Last-minute technical changes, or advanced technical reference material for experienced users or technicians 	<p>Installation software CD</p> <p>Note: If you purchased your Dell computer and printer at the same time, then documentation and drivers for your printer are already installed on your computer.</p>
<ul style="list-style-type: none"> • Supplies and accessories for your printer • Replacement cartridges 	<p>Dell Printer Supplies Web site—dell.com/supplies</p> <p>You can purchase printer supplies online, by telephone, or in select retail stores.</p>
<ul style="list-style-type: none"> • Safety information for preparing to operate your printer • Regulatory information • Warranty information 	<p><i>Product Information Guide</i></p> <div data-bbox="1068 1430 1263 1675" data-label="Image"> </div> <p>Note: The <i>Product Information Guide</i> may not be available in your country or region.</p>

Understanding the parts of the printer

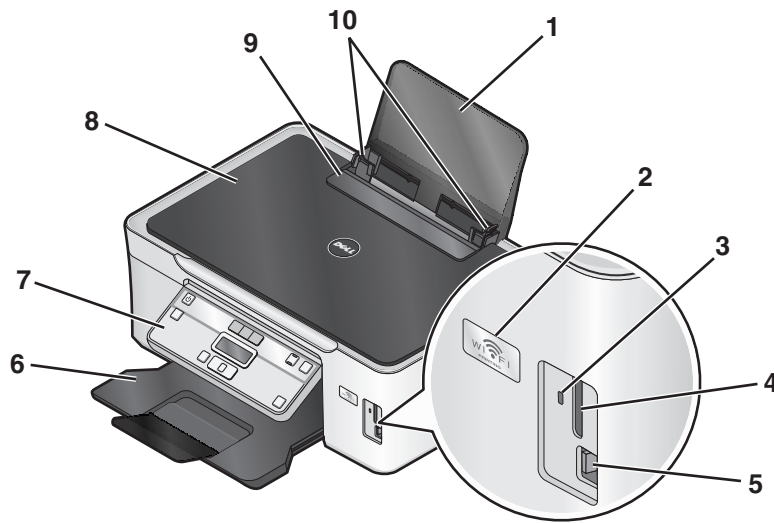

	Use the	To
1	Paper support	Load paper.
2	Wi-Fi indicator	Check wireless status. Note: This feature is available in selected models only.
3	Card reader light	Check card reader status. The light blinks to indicate that a memory card is being accessed.
4	Memory card slots	Insert a memory card.
5	PictBridge and USB port	Connect a PictBridge-enabled digital camera, USB Bluetooth adapter, or a flash drive to the printer.
6	Paper exit tray	Hold paper as it exits.
7	Printer control panel	Operate the printer.
8	Top cover	Access the scanner glass.
9	Paper feed guard	Prevent items from falling into the paper slot.
10	Paper guides	Keep paper straight when feeding.

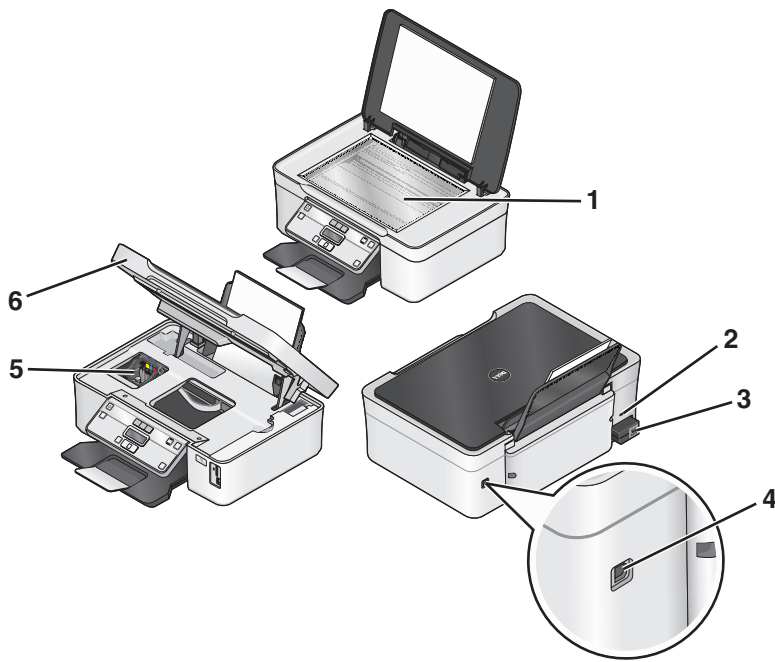

	Use the	To
1	Scanner glass	Scan and copy photos and documents.
2	Security slot	Install an anti-theft cable on your printer.
3	Power supply with port	Connect the printer to a power source.
4	USB port	Connect the printer to a computer using a USB cable. Warning—Potential Damage: Do not touch the USB port except when plugging in or removing a USB cable or installation cable.
5	Printhead	Install, replace, or remove ink cartridges.
6	Scanner unit	<ul style="list-style-type: none"> • Access the ink cartridges and printhead. • Remove paper jams.

Ordering and replacing supplies

Replacing ink cartridges

Make sure you have a new ink cartridge or cartridges before you begin. You must install new cartridges immediately after removing the old ones, or the ink remaining in the printhead nozzles may dry out.

- 1 Turn on your printer.
- 2 Open the printer.

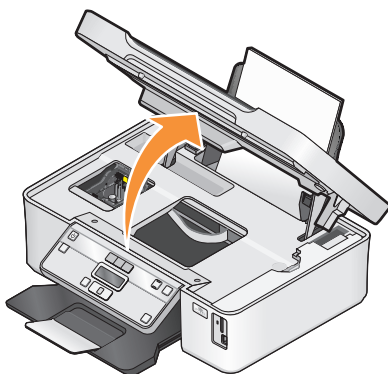

Note: The printhead moves to the cartridge installation position.

- 3 Press the release tab, and then remove the used ink cartridge or cartridges.

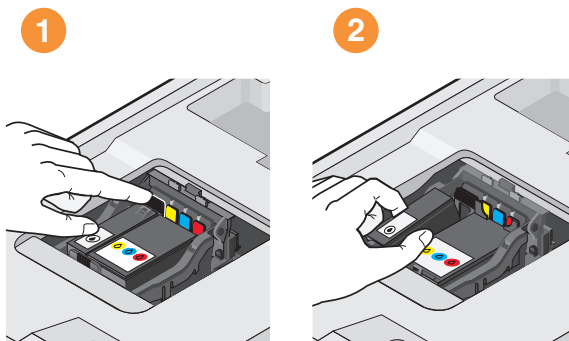

Note: Do not reinstall used ink cartridges once you remove them from the printhead.

- 4 Remove the new cartridges from the foil, and then remove the protective cap from each of the ink cartridges. Install the black ink cartridge and then the color ink cartridge. Use two hands to install each cartridge.

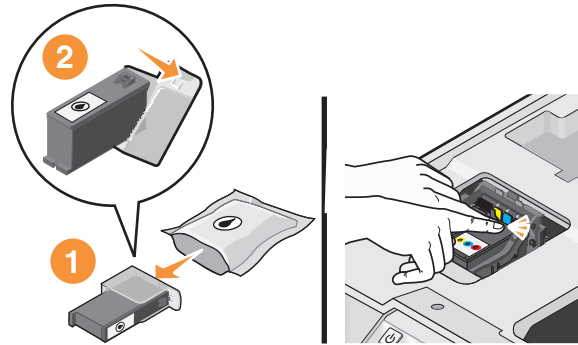

Note: Install the ink cartridges immediately after removing the protective cap to avoid exposing the ink to air.

- 5 Close the printer.

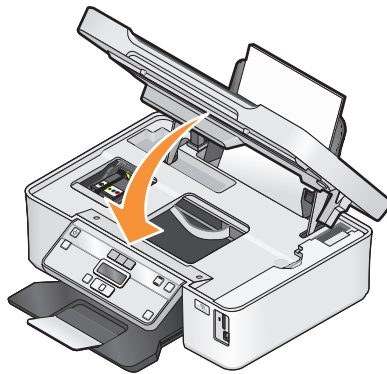

Ordering ink cartridges

Page yields available at www.dell.com/supplies. For best results, use only Dell ink cartridges.



Item	Licensed cartridge ¹	Regular cartridge
Black cartridge	Series 21	Series 21R
Black cartridge, high yield ²	Series 22	Series 22R
Color cartridge	Series 21	Series 21R
Color cartridge, high yield ²	Series 22	Series 22R

¹ Licensed for a single use only. After use, return this cartridge to Dell for remanufacturing, refilling, or recycling. To know more about recycling Dell products, visit www.dell.com/recycling.

² Available only on the Dell Web site at www.dell.com/supplies.

Recycling Dell products

To return Dell products to Dell for recycling:







- 1 Click  or **Start**.
- 2 Click **All Programs** or **Programs**, and then select the printer program folder from the list.
- 3 Select **Printer Home**.
- 4 Choose your printer from the printer drop-down list.
- 5 Click **Order supplies** in the Maintenance tab.
- 6 Click .
- 7 Follow the instructions on the computer screen.

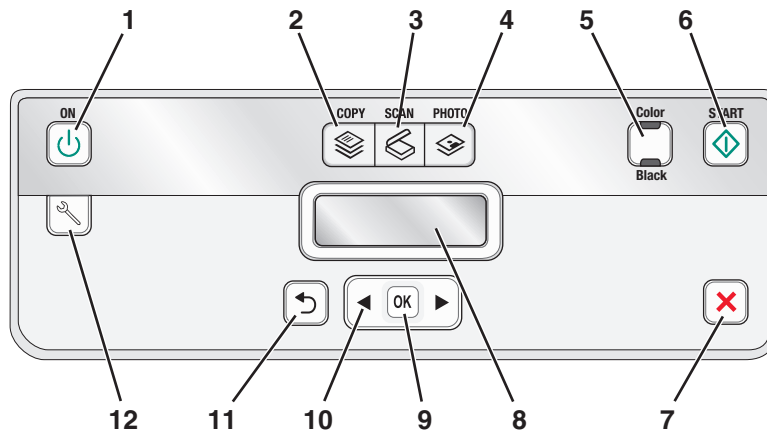



Using the printer control panel buttons and menus

Using the printer control panel

The following diagrams explain the sections of the printer control panel:



	Use the:	To
1	Power button 	<ul style="list-style-type: none"> Turn the printer on and off. Switch to Power Saver mode. <p>Note: When the printer is on, press  to switch to Power Saver mode. Press and hold  for three seconds to turn off the printer.</p>
2	Copy button 	Access the copy menu and make copies.
3	Scan button 	Access the scan menu and scan documents.
4	Photo button 	Access the photo menu and print photos.
5	Color/Black	Switch to color mode or black-and-white mode.
6	Start button 	Start a print, scan, or copy job, depending on which mode is selected.

	Use the:	To
7	Cancel button 	<ul style="list-style-type: none"> • Cancel a print, copy, or scan job in progress. • Exit from a menu level of the Copy, Scan, Photo, or File Print menu to the top level of a menu. • Exit from a menu level of the Setup menu to the top level of the previous mode. • Clear current settings or error messages, and return to default settings.
8	Display Note: The display is turned off in Power Saver mode.	View: <ul style="list-style-type: none"> • Printer status • Messages • Menus
9	Select button 	<ul style="list-style-type: none"> • Select menu options. • Save settings. • Feed or eject paper. Press and hold for 3 seconds to feed or eject paper from the printer.
10	Arrow buttons	<ul style="list-style-type: none"> • Choose a menu or submenu item that appears on the display.
11	Back button 	<ul style="list-style-type: none"> • Return to the previous screen. • Exit from one menu level to a higher one.
12	Setup button 	Access the setup menu and change printer settings. Note: The Copy, Scan and Photo button lights are off when this button is selected.

Using the printer menus

Copy menu	Scan menu	PictBridge menu ¹
<ul style="list-style-type: none"> Copies Quality Lighter/Darker Resize Original Size Photo Reprint Collate Pages per Sheet Copies per Sheet Content Type ID Card Copy 	<ul style="list-style-type: none"> Scan to <ul style="list-style-type: none"> • Computer <ul style="list-style-type: none"> – Application – Quality – Original Size • Network <ul style="list-style-type: none"> – Quality – File Type – Original Size • USB Flash Drive <ul style="list-style-type: none"> – Quality – File Type – Original Size • Memory Card <ul style="list-style-type: none"> – Quality – File Type – Original Size 	<ul style="list-style-type: none"> Paper Size Photo Size Paper Type Quality Layout

¹ This menu appears only when a PictBridge-enabled camera is inserted into the PictBridge port.

Photo menu			
<ul style="list-style-type: none"> Easy Photo <ul style="list-style-type: none"> • Print <ul style="list-style-type: none"> – Last Photo – All Photos – Date Range – Photo Number • Paper Size • Photo Size 	<ul style="list-style-type: none"> Print Photos <ul style="list-style-type: none"> • Print <ul style="list-style-type: none"> – Last Photo – All Photos – Date Range – Photo Number – Print DPOF¹ • Lighter/Darker 	<ul style="list-style-type: none"> • Photo Effects <ul style="list-style-type: none"> – None – Auto Enhance – Sepia – Antique Grey – Antique Brown • Paper Size • Photo Size • Paper Type • Layout • Quality 	<ul style="list-style-type: none"> Proof Sheet <ul style="list-style-type: none"> • Print Last 20 • Print All • Print Date Range • Scan Sheet Save Photos <ul style="list-style-type: none"> • Computer • USB Flash Drive² • Memory Card² Select Computer (appears only in printers connected to a network)

¹ This menu appears only when there is a valid DPOF file in your memory device.

² This menu appears only when a memory device is inserted into the card slot or USB port.

Setup menu			
Paper Setup <ul style="list-style-type: none"> Paper Size Paper Type Maintenance <ul style="list-style-type: none"> Ink Levels Clean Printhead Deep Clean Printhead Align Printer Print Test Page Replace Printhead 	Device Setup <ul style="list-style-type: none"> Language Country/Region Power Saver Auto Screen Dim Eco-Mode Clear Settings Timeout Network Setup ¹ <ul style="list-style-type: none"> Print Setup Page Wi-Fi Protected Setup Wireless Information TCP/IP File Print Reset Network Adapter Defaults 	Bluetooth Setup ² <ul style="list-style-type: none"> Enable Discovery Printer Name Security Level Paper Size Photo Size Paper Type Quality Pass Key Clear Device List 	Defaults <ul style="list-style-type: none"> Photo Print Size Set Defaults <ul style="list-style-type: none"> Use Current Use Factory Demo Mode <ul style="list-style-type: none"> On Off
¹ This menu appears only in printers that support wireless printing.			
² This menu appears only when a USB Bluetooth adapter is inserted into the USB port.			

Note: The File Print menu is enabled when you insert a memory device that contains document files into the printer. The menu is composed of the folders and files stored on the memory device.



Changing temporary settings into new default settings

The following menus revert to default settings after two minutes of inactivity or after the printer is turned off:

Copy menu	<ul style="list-style-type: none"> Copies Quality Lighter/Darker Resize Original Size Pages per Sheet Copies per Sheet Content Type
Scan menu	<ul style="list-style-type: none"> Quality Original Size
Fax menu (selected models only)	<ul style="list-style-type: none"> Lighter/Darker Quality



Photo menu	<p>The following Photo options will not time out after two minutes of inactivity or after you turn off the printer, but they will return to the factory default settings when a memory card or flash drive is removed.</p> <ul style="list-style-type: none"> • Photo Effects • Photo Size • Layout • Quality
------------	---

To change the temporary settings into new default settings

- 1 From the printer control panel, press .
- 2 Press the arrow buttons to scroll to **Defaults**, and then press .
- 3 Press the arrow buttons to scroll to **Set Defaults**, and then press .
Use Current appears on the display.
- 4 Press again to select **Use Current**.
- 5 Press  until you exit Setup, or press another mode button.



To disable the settings timeout feature

You can disable the settings timeout feature if you do not want the printer to revert to the default settings after two minutes of inactivity or after the printer is turned off.

- 1 From the printer control panel, press .
- 2 Press the arrow buttons to scroll to **Device Setup**, and then press .
- 3 Press the arrow buttons to scroll to **Clear Settings Timeout**, and then press .
- 4 Press the arrow buttons to scroll to **Never**, and then press .
- 5 Press  until you exit Setup, or press another mode button.

Changing the Power Saver timeout

The Power Saver timeout is the time it takes for the printer to switch to Power Saver mode when the printer is left idle. The Power Saver feature optimizes energy efficiency by reducing the printer power consumption (as much as 28 percent on some printer models) compared to the default printer settings. To save the most energy, select the lowest Power Saver timeout.

- 1 From the printer control panel, press .
- 2 Press the arrow buttons to scroll to **Device Setup**, and then press .
- 3 Press the arrow buttons to scroll to **Power Saver**, and then press .
- 4 Press the arrow buttons to select a Power Saver timeout, and then press .
- 5 Press  until you exit Setup, or press another mode button.





Resetting to factory settings

Resetting to factory default settings will delete all the printer settings you have previously selected.

Using the printer control panel menus

- 1 From the printer control panel, press .
- 2 Press the arrow buttons to scroll to **Default**s, and then press **OK**.
- 3 Press the arrow buttons to scroll to **Set Default**s, and then press **OK**.
- 4 Press the arrow buttons to scroll to **Use Factory**, and then press **OK**.
- 5 When prompted to set the initial settings of your printer, make your selections using the printer control panel buttons.
Initial Setup Complete appears on the display.

Using a button combination (if you cannot read the current language)

- 1 Turn off the printer.
Note: If you have set the Power Saver timeout in the Setup menu, then press and hold the  for three seconds to turn off the printer.
- 2 From the printer control panel, press and hold  and , and then press  to turn the printer on.
- 3 Release all three buttons.
- 4 When prompted to set the initial settings of your printer, make your selections using the printer control panel buttons.
Initial Setup Complete appears on the display.

Saving energy with Eco-Mode

The Eco-Mode feature optimizes energy efficiency and saves money.

When Eco-Mode is enabled, the printer automatically switches to the following settings:



- The printer display is dimmed.
- The printer changes to Power Saver mode after ten minutes.

Notes:

- If you are using Eco-Mode, then the Eco-Mode settings override any changes you may make to individual settings that are part of Eco-Mode.
- Eco-Mode is enabled by default.

To change the Eco-Mode setting:

- 1 From the printer control panel, press .
- 2 Press the arrow buttons to scroll to **Device Setup**, and then press **OK**.

- 3 Press the arrow buttons to scroll to **Eco-Mode**.
- 4 Select the Eco-Mode setting, and then press .
- 5 Press  until you exit Setup, or press another mode button.

Using the printer software

Minimum system requirements

The printer software requires up to 500 MB of free disk space.

Supported operating systems

- Microsoft Windows 7 (Web only)
- Microsoft Windows Vista
- Microsoft Windows XP
- Microsoft Windows 2000 (SP4 or greater)
- Linux Ubuntu 8.04 LTS and 8.10 (Web only)
- Linux OpenSUSE 11.0 and 11.1 (Web only)
- Linux Fedora 10 (Web only)

Using the Windows printer software

Software installed during printer installation

When you set up the printer using the installation software CD, all the necessary software was installed. You may have chosen to install some additional programs. The following table provides an overview of various software programs and what they can help you do.

If you did not install these additional programs during initial installation, then reinsert the installation software CD, run the installation software, and then select **Install Additional Software** from the Software Already Installed screen.

Printer software

Use the	To
Dell Printer Home (referred to as Printer Home)	<ul style="list-style-type: none">• Launch applications or programs.• Access the Fax Solutions software.• Scan or e-mail a photo or document.• Edit scanned documents.• Scan documents to PDF.• Adjust settings for the printer.• Order supplies.• Maintain ink cartridges.• Print a test page.• Register the printer.• Contact technical support.
Dell Fast Pics (referred to as Fast Pics)	Manage, edit, transfer, and print photos and documents.

Use the	To
Adobe™ Photo Album Starter Edition	View, manage, and edit photos.
Dell Toolbar (referred to as Toolbar)	Print, scan, or convert local files from Windows.
Dell Ink Management System	Order ink.
Dell Fax Solutions (referred to as Fax Solutions)	<ul style="list-style-type: none"> • Send a fax. • Receive a fax in three-in-one printers. • Add, edit, or delete contacts in the built-in phone book. • Access the Dell Fax Setup Utility. Use the Fax Setup Utility to set the Speed Dial and Group Dial numbers, set Ringing and Answering, and print fax history and status reports.
Abbyy Sprint OCR	Scan a document and produce text that you can edit with a word-processing program.
Dell Wireless Setup Utility (referred to as Wireless Setup Utility)	<ul style="list-style-type: none"> • Set up the wireless printer on a wireless network. • Change the wireless settings of the printer. <p>Note: This program is installed automatically with the printer software if the printer has wireless capability.</p>
Dell Service Center (referred to as Service Center)	<ul style="list-style-type: none"> • Troubleshoot the printer. • Access the printer maintenance functions. • Contact technical support. <p>Notes:</p> <ul style="list-style-type: none"> • This program is installed automatically with the printer software. • You may be prompted to install this program from the Web, depending on your printer model.
Printing Preferences	<p>When you select File → Print with a document open and then click Properties, a Printing Preferences dialog appears. The dialog lets you select options for the print job, such as the following:</p> <ul style="list-style-type: none"> • Select the number of copies to print. • Print two-sided copies. • Select the paper type. • Add a watermark. • Enhance images. • Save settings. <p>Note: Printing Preferences is installed automatically with the printer software.</p>

Note: Your printer may not come with some of these programs or some of the functions of these programs, depending on the features of the printer that you purchased.

Updating the printer software (Windows only)

Checking for software updates

- 1 Click  or **Start**.
- 2 Click **All Programs** or **Programs**, and then select the printer program folder from the list.
- 3 Select **Printer Home**.
- 4 Choose your printer from the printer drop-down list.
- 5 From the Support tab, select **Check for updates**.
- 6 Follow the instructions on the computer screen.

Reinstalling the printer software

If you encountered problems while installing, or if your printer does not appear in the Printers folder or as a printer option when you send a print job, then try removing and reinstalling the printer software.

Uninstalling the printer software

- 1 Click  or **Start**.
- 2 Click **All Programs** or **Programs**, and then select the printer program folder from the list.
- 3 Select the uninstall option.
- 4 Follow the instructions on the computer screen to remove the software.
- 5 Once the uninstall process is complete, restart your computer.

Installing the printer software

Note: If you installed the printer software on this computer before but need to reinstall the software, then uninstall the current software first.

- 1 Close all open software programs.
- 2 Insert the installation software CD.
If the Welcome screen does not appear after a minute, then launch the CD manually:
 - a Click , or click **Start** and then click **Run**.
 - b In the Start Search or Run box, type `D:\setup.exe`, where **D** is the letter of your CD or DVD drive.
- 3 Follow the instructions on the Welcome screen.

Using the World Wide Web

Updated printer software may be available at www.support.dell.com.

Loading paper and original documents

Loading paper

1 Fan the paper.

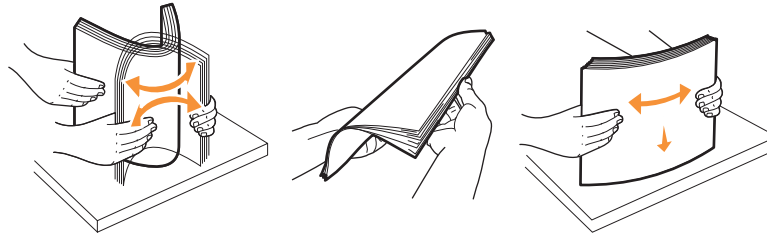

2 Center the paper on the paper support.

3 Adjust the paper guides so they rest against the edges of the paper.



Note: Do not force paper into the printer. The paper should be flat against the paper support, and the edges should be flush against both paper guides.

Paper and specialty media guidelines

Load up to:	Make sure that:
<p>100 sheets of plain paper</p> 	<ul style="list-style-type: none">• The paper guides rest against the edges of the paper.• You load letterhead paper with the print side faceup and the top of the letterhead going into the printer first.

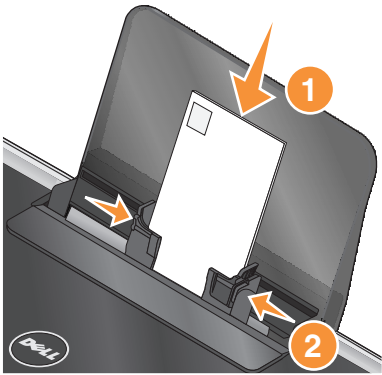
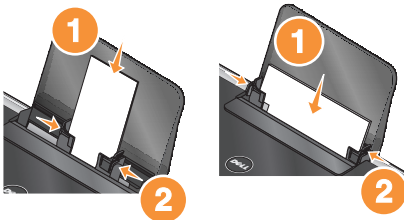
Load up to:	Make sure that:
<p>25 sheets of heavyweight matte paper</p>	<ul style="list-style-type: none"> The print side of the paper is faceup. The paper guides rest against the edges of the paper. You select Automatic, Normal, or Photo print quality. <p>Note: Draft mode is available but is not recommended for use with expensive paper such as heavyweight matte, labels, photo cards and glossy paper.</p>
<p>20 sheets of banner paper</p> 	<ul style="list-style-type: none"> You remove all paper from the paper support before inserting banner paper. You use banner paper designed for inkjet printers. You place a stack of banner paper on or behind the printer, and feed in the first sheet. The paper guides rest against the edges of the paper. You select A4 Banner or Letter Banner paper size.
<p>10 envelopes</p> 	<ul style="list-style-type: none"> The print side of the envelope is faceup. The paper guides rest against the edges of the envelopes. You print the envelopes with Landscape orientation. <p>Note: If you are mailing within Japan, then the envelope can be printed in Portrait orientation with the stamp in the lower right corner or in Landscape orientation with the stamp in the lower left corner. If you are mailing internationally, then print in Landscape orientation with the stamp in the upper left corner.</p>  <ul style="list-style-type: none"> You select the correct envelope size. Select the next biggest size if the exact envelope size is not listed, and set the left and right margins so your envelope is correctly positioned.
<p>25 sheets of labels</p>	<ul style="list-style-type: none"> The print side of the label is faceup. The paper guides rest against the edges of the paper. You select Automatic, Normal, or Photo print quality. <p>Note: Draft mode is available but is not recommended for use with expensive paper such as heavyweight matte, labels, photo cards and glossy paper.</p>

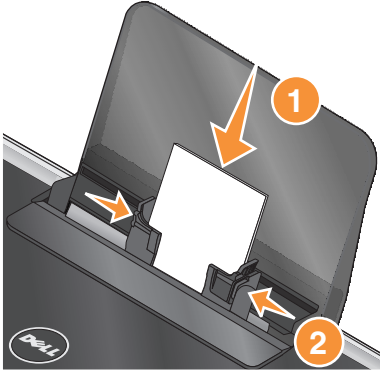
Load up to:	Make sure that:
<p>25 greeting cards, index cards, postcards, or photo cards</p> 	<ul style="list-style-type: none"> • The print side of the card is faceup. • The paper guides rest against the edges of the cards. • You select Automatic, Normal, or Photo print quality. <p>Note: Draft mode is available but is not recommended for use with expensive paper such as heavyweight matte, labels, photo cards and glossy paper.</p>
<p>25 sheets of photo/glossy paper</p>	<ul style="list-style-type: none"> • The print side of the paper is faceup. • The paper guides rest against the edges of the paper. • You select Automatic, Normal, or Photo print quality. <p>Note: Draft mode is available but is not recommended for use with expensive paper such as heavyweight matte, labels, photo cards and glossy paper.</p>
<p>10 iron-on transfers</p>	<ul style="list-style-type: none"> • You follow the loading instructions on the iron-on transfer packaging. • The print side of the transfer is faceup. • The paper guides rest against the edges of the transfer. • You select Automatic, Normal, or Photo print quality.
<p>50 transparencies</p>	<ul style="list-style-type: none"> • The rough side of the transparencies is faceup. • The paper guides rest against the edges of the transparencies.

Saving paper default settings

You can set the default paper size, paper type, and photo print size for the documents and photos that you print.

Note: These default settings apply only to print, copy, and scan jobs that you initiate from the printer.

- 1 From the printer control panel, press .
- 2 Choose the default settings:
 - If you want to set the default paper size:
 - a Press to select **Paper Setup**.
 - b Press the arrow buttons to scroll to **Paper Size**, and then press .
 - c Press the arrow buttons to select the default paper size for the printer, and then press .
 - If you want to set the default paper type:
 - a Press to select **Paper Setup**.
 - b Press the arrow buttons to scroll to **Paper Type**, and then press .
 - c Press the arrow buttons to select the default paper type for the printer, and then press .

- If you want to set the default photo print size:
 - a Press the arrow buttons to scroll to **Defaults**, and then press **OK**.
 - b Press **OK** to select **Photo Print Size**.
 - c Press the arrow buttons to select the default photo print size for the printer, and then press **OK**.

3 Press **↶** until you exit Setup, or press another mode button.

Loading original documents on the scanner glass

- 1 Open the top cover and place the document facedown on the scanner glass.
- 2 Close the top cover.

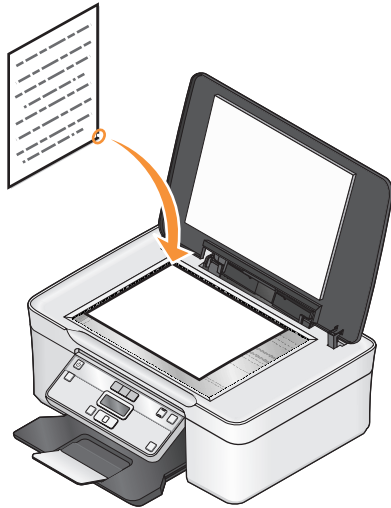

Printing

Tips for printing

- Use the appropriate paper for your print job.
- Select a higher print quality for better prints.
- Make sure there is enough ink in the ink cartridges.
- Remove each sheet as it is printed when printing photos or when working with specialty media.
- Select the borderless setting when printing photos.

Printing basic documents

Printing a document

- 1 Load the paper in the printer.
- 2 Send the print job:
 - a With a document open, click **File → Print**.
 - b Click **Properties, Preferences, Options, or Setup**.
 - c Select the print quality, the number of copies to print, the type of paper to use, and how the pages should print.
 - d Click **OK** to close any printer software dialogs.
 - e Click **OK** or **Print**.

Collating printed copies

If you print multiple copies of a document, then you can choose to print each copy as a set (collated) or to print the copies as groups of pages (not collated).

Collated



Not collated

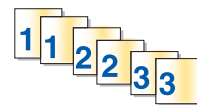

Notes:

- The collate option is available only when you are printing multiple copies.
 - To prevent smudging when printing photos, remove each photo as it exits the printer, and then let it dry before stacking.
- 1 With a document open, click **File → Print**.
 - 2 Click **Properties, Preferences, Options, or Setup**.
 - 3 From the Copies section of the Print Setup tab, enter the number of copies that you want to print, and then select **Collate Copies**.

4 Click **OK** to close any printer software dialogs.

5 Click **OK** or **Print**.

Printing pages in reverse order

By default, the first page is printed first. If you want to reverse the order in which pages print to make documents ready to read with the first page on top, then do the following:

1 With a document open, click **File → Print**.

2 Click **Properties, Preferences, Options, or Setup**.

3 From the Copies section of the Print Setup tab, select a page order:

- To print the last page first, select **Print Last Page First**.
- To print the first page first, clear the **Print Last Page First** check box.

Note: If two-sided printing is enabled, then you cannot print the last page first. To change the print order, you must first disable two-sided printing.

4 Click **OK** to close any printer software dialogs.

5 Click **OK** or **Print**.

Printing multiple pages on one sheet

1 With a document open, click **File → Print**.

2 Click **Properties, Preferences, Options, or Setup**.

3 From the Layout list of the Advanced tab, select **Pages per sheet**.

4 Select the number of page images to print on each page.

If you want each page image to be surrounded by a border, then select **Print Page Borders**.

5 Click **OK** to close any printer software dialogs.

6 Click **OK** or **Print**.

Printing documents from a memory card or flash drive

To enable the File Print function:

- The printer must be connected to a computer through a USB cable or through a network.
- The printer and the computer must be on.
- The memory card or flash drive must contain document files that are supported by the printer. For more information, see “Supported memory cards and file types” on page 36.
- The computer must contain applications that support the file types in the memory device.

1 Insert a memory card or flash drive.

When the printer detects the memory device, **Memory Card Detected** or **Storage Device Detected** appears on the display.

2 If only document files are stored on the memory device, then the printer automatically switches to File Print mode.

If document files and image files are stored on the memory device, then press **OK** to select **Documents**.

3 Select and print the document:

If the printer is using a USB connection

- a Press the arrow buttons to select the file name of the document that you want to print or the folder where the document is saved in the memory device.
- b Press **OK**, and then press **↵** to start printing the document.

If the printer is using a Wireless connection (selected models only)

- a Press the arrow buttons to select the file name of the document that you want to print.
- b Press **OK**, and then wait for the printer to connect to the network computer or to finish searching the network for available computers.
- c When prompted, press the arrow buttons to select the name of the network computer, and then press **OK** to start printing the document.

Notes:

- You may be prompted to enter a PIN if the computer requires it. Enter the PIN using the keypad.
- To assign a computer name and a PIN to the computer, see the Help for the printer software associated with your operating system.

Printing specialty documents

Printing envelopes

- 1 Load the envelopes in the printer.
- 2 Send the print job:
 - a With a document open, click **File → Print**.
 - b Click **Properties, Preferences, Options, or Setup**.
 - c From the Paper Type list of the Print Setup tab, select **Plain Paper**.
 - d From the Paper Size list, select the envelope size.

Note: To print on a custom-size envelope, select **Custom Size**, and then specify the height and width of the envelope.

- e Select an orientation.
- f Click **OK** to close any printer software dialogs.
- g Click **OK** or **Print**.

Notes:

- Most envelopes use landscape orientation.
- Make sure the same orientation is also selected in the software application.

Printing labels

- 1 Load the label sheets in the printer.
- 2 Send the print job:
 - a With a document open, click **File → Print**.
 - b Click **Properties, Preferences, Options, or Setup**.
 - c From the Paper Size list of the Print Setup tab, choose a paper size that matches the size of the label sheet. If no paper size matches the label sheet size, then set a custom size.
If necessary, choose the appropriate type of paper from the Paper Type list.
 - d Click **OK** to close any printer software dialogs.
 - e Click **OK** or **Print**.

Tips on loading label sheets

- Make sure the top of the label sheet feeds into the printer first.
- Make sure the adhesive on the labels does not extend to within 1 mm of the edge of the label sheet.
- Make sure the paper guide or paper guides rest against the edges of the label sheet.
- Use full label sheets. Partial sheets (with areas exposed by missing labels) may cause labels to peel off during printing, resulting in a paper jam.

Note: Labels require more drying time. Remove each label sheet as it exits, and then allow it to dry to avoid ink smudging.

Printing on custom-size paper

Before beginning these instructions, load the custom-size paper in the printer.

- 1 With a document open, click **File → Print**.
- 2 Click **Properties, Preferences, Options, or Setup**.
- 3 From the Paper Size list of the Print Setup tab, select **Custom Size**.
The Define Custom Paper Size dialog appears.
- 4 Set the paper size.
- 5 Select the measurement units to use (inches or millimeters).
- 6 Click **OK** to close any printer software dialogs.
- 7 Click **OK** or **Print**.

Printing on both sides of the paper (duplexing) manually

- 1 With a document open, click **File → Print**.
- 2 Click **Properties, Preferences, Options, or Setup**.
- 3 Click the **Advanced** tab.

4 From the 2-Sided Printing section, select **Manual**.

Note: The Print Instruction Page to Assist in Reloading item is selected automatically.

5 Click **OK**. The printer prints the odd-numbered pages and the instruction sheet.

6 Flip and reload the paper, following the directions on the instruction sheet to complete the print job.

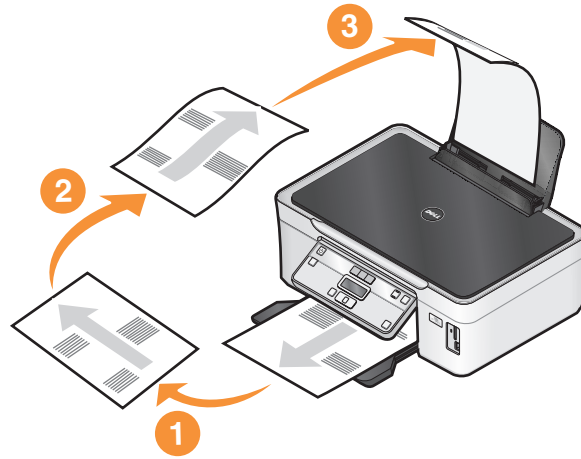

Note: To return to single-sided printing, return to the Advanced tab. From the 2-Sided Printing section, select **Off** from the drop-down menu.

Working with photos

Using a memory card or flash drive with the printer

Memory cards and flash drives are storage devices frequently used with cameras and computers. You can remove the memory card from the camera or the flash drive from the computer and insert it directly into the printer.

- 1 Insert a memory card into the card slot or a flash drive into the USB port.

Inserting a memory card

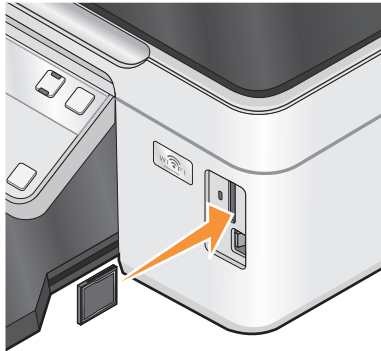

Notes:

- Insert the card with the brand name label facing right.
- Make sure any arrows on the card point toward the printer.
- If necessary, connect the memory card to the adapter that came with it.
- Make sure that the memory card inserted is supported by the printer. For more information, see “Supported memory cards and file types” on page 36.

Inserting a flash drive

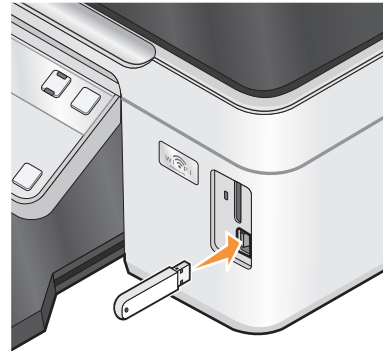

Notes:

- The flash drive uses the same port that is used for a PictBridge camera cable.
- An adapter may be necessary if your flash drive does not fit directly into the port.



Warning—Potential Damage: Do not touch any cables, any network adapter, any connector, the memory device, or the printer in the areas shown while actively printing, reading, or writing from the memory card. A loss of data can occur.

- 2 Look for **Memory Card Detected** or **Storage Device Detected** on the display.

Notes:

- If the printer does not recognize the memory device, then remove and reinsert it.
- If a flash drive or a digital camera set to mass storage mode is inserted into the USB port while a memory card is in the card slot, then a message appears on the display prompting you to choose which memory device to use.

Supported memory cards and file types

Memory Card	File Type
<ul style="list-style-type: none"> • Secure Digital (SD) • Micro Secure Digital (with adapter) (Micro SD) • Mini Secure Digital (with adapter) (Mini SD) • MultiMedia Card (MMC) • Reduced Size MultiMedia Card (with adapter) (RS-MMC) • MultiMedia Card mobile (with adapter) (MMCmobile) • Memory Stick • Memory Stick PRO • Memory Stick Duo (with adapter) • Memory Stick PRO Duo (with adapter) • xD-Picture Card • xD-Picture Card (Type H) • xD-Picture Card (Type M) • Secure Digital High Capacity (SDHC) 	<p>Documents:</p> <ul style="list-style-type: none"> • .doc (Microsoft Word) • .xls (Microsoft Excel) • .ppt (Microsoft PowerPoint) • .pdf (Adobe Portable Document Format) • .rtf (Rich Text Format) • .docx (Microsoft Word Open Document Format) • .xlsx (Microsoft Excel Open Document Format) • .pptx (Microsoft PowerPoint Open Document Format) • .wpd (WordPerfect) <p>Images:</p> <ul style="list-style-type: none"> • JPEG • TIFF

Printing photos using the printer control panel

- 1 Load photo paper.
- 2 From the printer control panel, press .
- 3 Insert a memory card, flash drive, or digital camera set to mass storage mode.
If image files and document files are stored in the memory device, then press the arrow buttons to select **Photos**.
- 4 Press the arrow buttons to scroll to **Easy Photo** or **Print Photos**, and then press .

Notes:

- Select **Easy Photo** if you want to print photos quickly.
- Select **Print Photos** if you want to customize the photos before printing them.

- 5 Press the arrow buttons to select a photo printing option, and then press .

Note: You can choose to print the most recent photo, print all the photos, print photos that fall within a date range, print photos by selecting the photo numbers on a proof sheet, or print pre-selected photos from a digital camera using Digital Print Order Format (DPOF). The DPOF option appears only when there is a valid DPOF file in your memory device.

- 6 Adjust the print settings:
 - If you are in the Easy Photo menu, then press the arrow buttons to select the paper size and photo size. Press each time you make a selection.
 - If you are in the Print Photos menu, then press the arrow buttons to select the photo size, paper size, paper type, layout, photo effects, and quality of the photos, and to adjust the brightness and color effects of the photos. Press each time you make a selection.

7 Press the **Color/Black** button to set a color or black-and-white print.

When you select color or black-only printing, the light near your choice comes on.

8 Press .

Note: For best results, allow the prints to dry at least 24 hours before stacking, displaying, or storing.

Printing photos from a memory device using the printer software

1 Load photo paper with the glossy or printable side faceup. (If you are not sure which side is the printable side, then see the instructions that came with the paper.)

2 From the printer control panel, press .

3 Insert a memory card, flash drive, or digital camera set to mass storage mode.

If document files and image files are stored on the memory device, then press the arrow buttons to scroll to **Photos**. Press .

4 Transfer or print the photos:

If the printer is using a USB connection

- Fast Pics launches automatically when you insert the memory device. Follow the instructions on the computer screen to transfer the photos to the computer or to print.

If the printer is using a Wireless connection (selected models only)

a Press the arrow buttons to scroll to **Select Computer**, and then press .

b Press the arrow buttons to select the network computer where you want to save the photos, and then press .

c Transfer or print the photos:

- Fast Pics launches on the computer. Follow the instructions on the computer screen to transfer the photos to the computer or to print.

Printing photos from a PictBridge-enabled digital camera

PictBridge is a technology available in most digital cameras that lets you print directly from your digital camera without using a computer.

1 Insert one end of the USB cable into the camera.

Note: Use only the USB cable that came with the camera.

2 Insert the other end of the cable into the PictBridge port on the front of the printer.

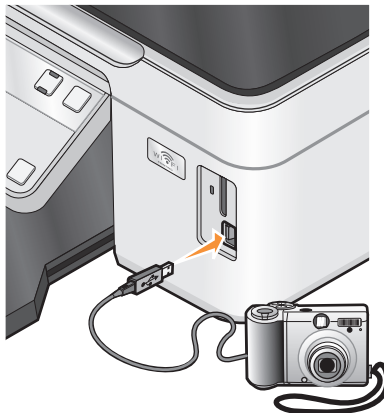

Notes:

- Make sure that the PictBridge-enabled digital camera is set to the correct USB mode. If the camera USB selection is incorrect, then the camera is detected as a flash drive, or an error message will be displayed on the printer control panel. For more information, see the camera documentation.
- The printer reads only one memory device at a time.

Warning—Potential Damage: Do not touch the USB cable, any network adapter, any connector, or the printer in the area shown while actively printing from a PictBridge-enabled digital camera. A loss of data can occur.



3 If the PictBridge connection is successful, then the following message appears on the display: **PictBridge Camera detected. Press OK to change settings.**







4 Press **OK** to access the PictBridge menu.

5 Press the arrow buttons to select the paper size, paper type, photo size, and layout of the photos that you want to print. Press **OK** each time you make a selection.

6 See the documentation for your camera to begin printing.

Note: If you insert the camera while the printer is performing another job, then wait for the job to finish before printing from the camera.



Printing photos from a memory device using the proof sheet

- 1 Load letter- or A4-size plain paper.
- 2 From the printer control panel, press .
- 3 Insert a memory card or flash drive.
- 4 Press the arrow buttons to scroll to **Proof Sheet**, and then press .
- 5 Press the arrow buttons to select an option to print a proof sheet.
You can print a proof sheet:
 - For all photos on the memory device.
 - For the 20 most recent photos, if there are 20 or more photos on the memory device.
 - By date, if the photos on the card were taken on different dates. If you choose this option, then press the arrow buttons to set the start and end dates, and then press  to save your selections.
- 6 Press .
- The proof sheet prints.
- 7 Follow the instructions on the proof sheet to select which photos to print, the number of copies per photo, red-eye reduction, page layout, print options, and paper size.
Note: When making selections, make sure to fill in the circles completely.
- 8 Load the proof sheet facedown on the scanner glass.
Scan Proof Sheet appears on the display.
Note: If this option does not appear on the display, then press the arrow buttons until it appears on the display.
- 9 Press .
- The printer scans the proof sheet.
- 10 Load photo paper with the glossy or printable side faceup. (If you are not sure which side is the printable side, then see the instructions that came with the paper.)
Note: Make sure that the paper matches the size that you selected on the proof sheet.
- 11 Press the **Color/Black** button to set a color or black-and-white print.
When you select color or black-only printing, the light near your choice comes on.
- 12 Press  to print the photos.
Note: To prevent smudging or scratching, avoid touching the printed surface with your fingers or sharp objects. For best results, remove each printed sheet individually from the paper exit tray, and then allow the prints to dry at least 24 hours before stacking, displaying, or storing.

Printing photos from a digital camera using DPOF

If your camera supports Digital Print Order Format (DPOF), then you can specify which photos to print, how many of each, and the print settings while the memory card is still in the camera. The printer recognizes these settings when you insert the memory card into the printer or connect the camera to the printer.

Note: If you specify a photo size while the memory card is still in the camera, then make sure that the size of the paper loaded in the printer is not smaller than the size you specify in the DPOF selection.

- 1 Load photo paper with the glossy or printable side faceup. (If you are not sure which side is the printable side, then see the instructions that came with the paper.)
- 2 From the printer control panel, press .
- 3 Insert a memory card.
Memory Card Detected appears on the display.
- 4 Press the arrow buttons to scroll to **Print Photos**, and then press .
- 5 Press the arrow buttons to scroll to **Print DPOF**, and then press  to print the photos.

Note: This option appears only if a DPOF file is detected in the memory card.

Note: To prevent smudging or scratching, avoid touching the printed surface with your fingers or sharp objects. For best results, remove each printed sheet individually from the paper exit tray, and allow the prints to dry at least 24 hours before stacking, displaying, or storing.

Printing from a Bluetooth-enabled device

- This printer is compliant with Bluetooth Specification 2.0. It supports the following profiles: Object Push Profile (OPP) and Serial Port Profile (SPP). Check with your Bluetooth-enabled device manufacturers (cellular phone or PDA) to determine their hardware compatibility and interoperability. It is recommended that you use the latest firmware on your Bluetooth-enabled device.
- To print Microsoft documents from your Windows Mobile/Pocket PC PDA, additional third-party software and drivers are required. For more information about the required software, see the documentation for your PDA.

Setting up a connection between your printer and a Bluetooth-enabled device

Note: The printer does not support printing files from your computer using a Bluetooth connection.

You need to set up a connection between a Bluetooth-enabled device and your printer if you are sending a print job from the Bluetooth device for the first time. You will need to repeat the setup if:

- You reset the printer to its factory default settings.
- You change the Bluetooth security level or the Bluetooth pass key.

- The Bluetooth-enabled device you are using requires users to set up a Bluetooth connection on every print job. For more information, see the documentation for your Bluetooth device.
- The name of the Bluetooth device you are using is automatically deleted from the Bluetooth device list.

When the Bluetooth security level is set to High, the printer saves a list of up to eight Bluetooth devices that have previously set up a connection with the printer. When the printer detects more than eight devices, the least recently used device is removed from the list. You need to repeat the setup of the deleted device to be able to send a print job to the printer.

Note: You need to set up a connection for each Bluetooth device that you use to send a print job to the printer.

To set up a connection between the printer and a Bluetooth-enabled device:

- 1 Insert a USB Bluetooth adapter into the USB port located on the front of the printer.

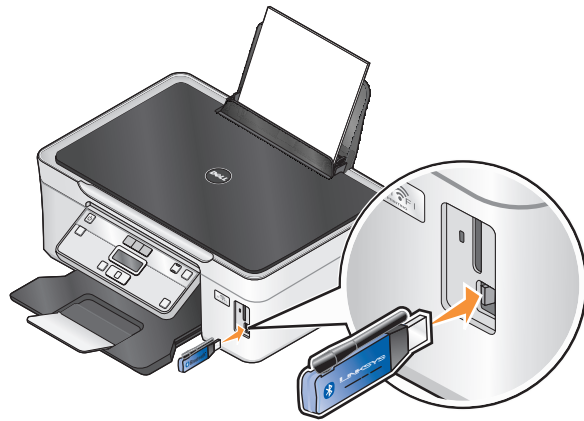

Bluetooth Dongle Connected appears on the display.

Note: A Bluetooth adapter is not included with the printer.

- 2 From the printer control panel, press .
- 3 Press the arrow buttons to scroll to **Bluetooth Setup**, and then press **OK**.
- 4 Press the arrow buttons to scroll to **Discovery**, and then press **OK**.
- 5 Make sure Discovery is set to On. If necessary, press the arrow buttons to scroll to **On**, and then press **OK**.
The printer is now ready to accept a connection from a Bluetooth-enabled device.
- 6 Configure the Bluetooth-enabled device to set up a connection to the printer. For more information, see the documentation for your Bluetooth device.

Note: If the Bluetooth Security Level on the printer is set to High, then you must enter a pass key.



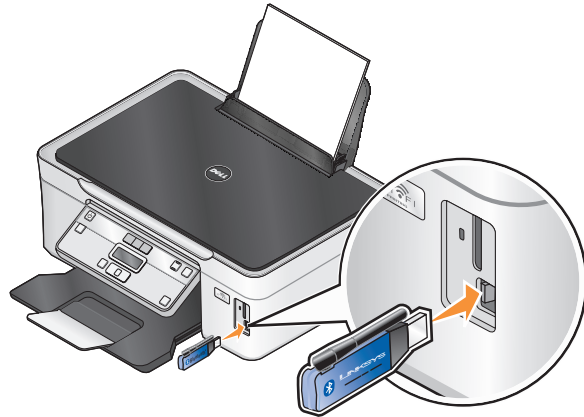

Setting the Bluetooth security level

- 1 Insert a Bluetooth USB adapter into the USB port.



Bluetooth Dongle Connected appears on the display.

Note: A Bluetooth adapter is not included with the printer.

- 2 From the printer control panel, press .
- 3 Press the arrow buttons to scroll to **Bluetooth Setup**, and then press button .
- 4 Press the arrow buttons to scroll to **Security Level**, and then press .
- 5 Press the arrow buttons to select the security level, and then press 
 - Select **Low** to allow Bluetooth devices to connect and send print jobs to your printer without requiring users to enter a pass key.
 - Select **High** to require users to enter a four-digit numeric pass key on the Bluetooth device before connecting and sending print jobs to the printer.
- 6 The Bluetooth Pass Key menu appears on the display if you set the security level to High. Use the keypad to enter your four-digit pass key, and then press .

Printing from a Bluetooth-enabled device

Note: The printer does not support printing files from your computer using a Bluetooth connection.

- 1 Insert a USB Bluetooth adapter into the USB port.

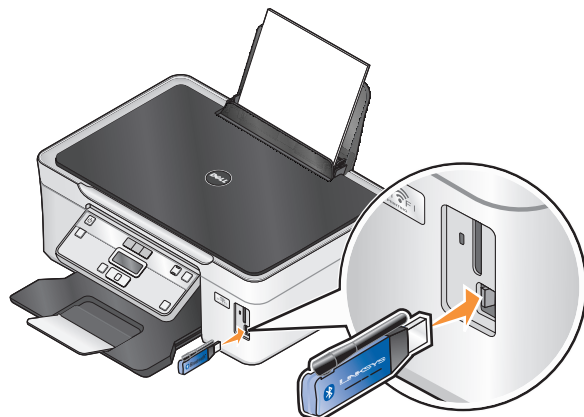

Bluetooth Dongle Connected appears on the display.

Warning—Potential Damage: Do not touch cables, any network adapter, any connector, the USB Bluetooth adapter, or the printer in the areas shown while actively printing, reading, or writing from a Bluetooth-enabled device. A loss of data can occur.

Notes:

- A Bluetooth adapter is not included with the printer.
 - Your printer automatically switches to Bluetooth mode when you insert a USB Bluetooth adapter.
- 2 Make sure the printer is set up to receive Bluetooth connections. For more information, see “Setting up a connection between your printer and a Bluetooth-enabled device” on page 40.
 - 3 Set up the Bluetooth device to print to the printer. For more information, see the documentation for your Bluetooth device.
 - 4 See the documentation for your Bluetooth device to begin printing.

Note: If the Bluetooth Security Level on the printer is set to High, you must enter a pass key.

Managing print jobs

Setting your printer as the default printer

Your printer should be selected automatically from the Print dialog when you send a print job. If you have to manually select your printer, then it is not the default printer.

To set the default printer:

- 1 Click , or click **Start** and then click **Run**.
- 2 In the Start Search or Run box, type **control printers**.
- 3 Press **Enter**, or click **OK**.
The printer folder opens.
- 4 Right-click the printer, and then select **Set as Default Printer**.

Changing the printing mode

To conserve ink, you can change the default printing mode for all print jobs to Quick Print. It uses less ink and is ideal for printing text-only documents. If you need to change to a different print mode to print photos or other high-quality documents, then you can select a different mode from the Print dialog before sending the print job.

To change the default print mode:

- 1 Click , or click **Start** and then click **Run**.
- 2 In the Start Search or Run box, type **control printers**.
- 3 Press **Enter**, or click **OK**.
The printer folder opens.
- 4 Right-click the printer, and then select **Printing Preferences**.
- 5 Select **Quick Print** as the printing mode.

Changing the printing mode for a single print job

- 1 With a document open, click **File → Print**.
- 2 Click **Properties, Preferences, Options, or Setup**.
- 3 Select **Automatic, Quick Print, Normal, or Best**.

Note: Printing in Draft mode uses less ink and is ideal for printing text documents.

Pausing print jobs

- 1 Click , or click **Start** and then click **Run**.
- 2 In the Start Search or Run box, type `control printers`.
- 3 Press **Enter**, or click **OK**.
The printer folder opens.
- 4 Right-click the printer, and then select **Pause Printing**.

Resuming print jobs

- 1 Click , or click **Start** and then click **Run**.
- 2 In the Start Search or Run box, type `control printers`.
- 3 Press **Enter**, or click **OK**.
The printer folder opens.
- 4 Right-click the printer, and then select **Open**.
- 5 Resume the print job:
 - If you want to resume a particular print job, then right-click the document name, and then select **Resume**.
 - If you want to resume all print jobs in the queue, then click **Printer**, and then clear the selection for Pause Printing.

Canceling print jobs

To cancel a print job from the printer control panel, press . To cancel a print job from the computer, do the following:

- 1 Click , or click **Start** and then click **Run**.
- 2 In the Start Search or Run box, type `control printers`.
- 3 Press **Enter**, or click **OK**.
The printer folder opens.
- 4 Right-click the printer, and then select **Open**.
- 5 Cancel the print job:
 - If you want to cancel a particular print job, then right-click the document name, and then select **Cancel**.
 - If you want to cancel all print jobs in the queue, then click **Printer → Cancel All Documents**.

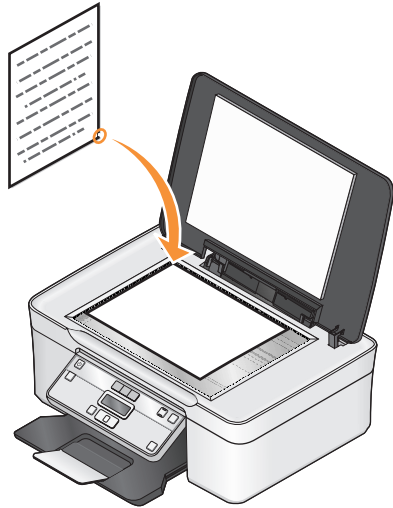

Copying

Automatic Document Feeder (ADF)	Scanner glass
<p>Use the ADF for multiple-page documents.</p> <p>Note: The ADF is available only on selected models. If you purchased a printer without an ADF, then load original documents or photos on the scanner glass.</p>	 <p>Use the scanner glass for single pages, small items (such as postcards or photos), transparencies, photo paper, or thin media (such as magazine clippings).</p>





Tips for copying

- When using the ADF, adjust the paper guide on the ADF to the width of the original document.
- When using the scanner glass, close the top cover to avoid dark edges on the scanned image.
- Do *not* load postcards, photos, small items, transparencies, photo paper, or thin media (such as magazine clippings) into the ADF. Place these items on the scanner glass.

Making copies



- 1 Load paper.
- 2 Load an original document faceup into the ADF or facedown on the scanner glass.
- 3 From the printer control panel, press .
- 4 Press the arrow buttons to select the number of copies, and then press the **Color/Black** button to set a color or black-and-white copy.
When you select color or black-only printing, the light near your choice comes on.
- 5 Press .

Copying photos



- 1 Load photo paper with the glossy or printable side faceup. (If you are not sure which side is the printable side, then see the instructions that came with the paper.)
- 2 Place a photo facedown on the scanner glass.
- 3 From the printer control panel, press .
- 4 Press  until **Photo Reprint** appears.
- 5 Press the arrow buttons to scroll to **Yes**, and then press .
- 6 Press the arrow buttons to select the desired paper size, and then press .
- 7 Press .

Note: To prevent smudging or scratching, avoid touching the printed surface with your fingers or sharp objects. For best results, remove each printed sheet individually from the paper exit tray, and allow the prints to dry at least 24 hours before stacking, displaying, or storing.

Enlarging or reducing images

- 1 Load paper.
- 2 Load an original document facedown on the scanner glass.
- 3 From the printer control panel, press .
- 4 Press  until **Resize** appears.
- 5 Press the arrow buttons until the setting that you want appears.



Notes:

- If you select Custom % Resize, then press , and then press the arrow buttons to select the desired custom percent value. Press  to save the setting.
- If you select Borderless, then the printer will reduce or enlarge the document or photo as necessary to print a borderless copy on the paper size that you selected. For best results with this resize setting, use photo paper and set the paper type to Photo, or let the printer automatically detect the paper type.

- 6 Press .

Note: After the copy job is finished, press  to reset the settings to the default. The resize setting also switches to 100% after two minutes of printer inactivity.

Adjusting copy quality

- 1 Load paper.
- 2 Load an original document faceup into the ADF or facedown on the scanner glass.
- 3 From the printer control panel, press .
- 4 Press  until **Quality** appears.

- 5 Press the arrow buttons to set the copy quality to Automatic, Draft, Normal, or Photo, and then press to save your setting.
- 6 Press .

Making a copy lighter or darker

- 1 Load paper.
- 2 Load an original document faceup into the ADF or facedown on the scanner glass.
- 3 From the printer control panel, press .
- 4 Press until **Lighter/Darker** appears.
- 5 Press the arrow buttons to adjust the slider, and then press to save your setting.

Note: Pressing the left arrow button makes the copy lighter, and pressing the right arrow button makes the copy darker.

- 6 Press .

Collating copies using the printer control panel

If you print multiple copies of a document, then you can choose to print each copy as a set (collated) or to print the copies as groups of pages (not collated).

Collated





Not collated



- 1 Load paper.
- 2 Load an original document faceup into the ADF or facedown on the scanner glass.
- 3 From the printer control panel, press .
- 4 Press the arrow buttons to select the number of copies, and then press .
- 5 Press until **Collate** appears.
- 6 Press the arrow buttons to scroll to **On**.
- 7 Press to save the image to the printer memory.
- 8 When asked if you want to scan another page, press to select **Yes**.
- 9 Load the next page of the original document faceup into the ADF or facedown on the scanner glass, and then press .
- 10 Repeat steps 8 and 9 until all the pages that you want to copy have been saved to the printer memory.
- 11 When asked if you want to scan another page, press the arrow buttons to scroll to **No**, and then press to start printing the copies.







Repeating an image on one page

You can print the same page image multiple times on one sheet of paper. This option is helpful when creating items such as labels, decals, flyers, and handouts.

- 1 Load paper.
- 2 Load an original document faceup into the ADF or facedown on the scanner glass.
- 3 From the printer control panel, press .
- 4 Press  until **Copies per Sheet** appears.
- 5 Press the arrow buttons to select the number of times that an image is repeated on a page: once, four times, nine times, or 16 times.
- 6 Press .

Copying multiple pages on one sheet

The Pages per Sheet setting lets you copy multiple pages on one sheet by printing smaller images of each page. For example, you can condense a 20-page document into five pages if you use this setting to print four page images per sheet.

- 1 Load paper.
- 2 Load an original document faceup into the ADF or facedown on the scanner glass.
- 3 From the printer control panel, press .
- 4 Press  until **Pages per Sheet** appears.
- 5 Press the arrow buttons to select the number of pages that you want to copy on a sheet of paper. You may choose to copy one, two, or four page images on a sheet.
Note: If you are copying four pages in landscape format, scan pages 3 and 4 first, and then scan pages 1 and 2.
- 6 Press  to save the image of the page to the printer memory.
- 7 When asked if you want to scan another page, press  to select **Yes**.
- 8 Load the next page of the original document faceup into the ADF or facedown on the scanner glass, and then press .
- 9 Repeat steps 7 and 8 until all the pages that you want to copy have been saved to the printer memory.
- 10 When asked if you want to scan another page, press the arrow buttons to scroll to **No**, and then press  to start printing.

Making a duplex copy manually

- 1 Load paper.
- 2 Load an original document faceup into the ADF or facedown on the scanner glass.
- 3 From the printer control panel, press .

4 Press the left or right arrow button to select the number of copies, and then press the **Color/Black** button to set a color or black-and-white copy.

When you select color or black-only printing, the light near your choice comes on.

5 Press .

6 Load the next page of the document.

- If you are copying a one-sided document, then load the next page faceup into the ADF or facedown on the scanner glass.
- If you are copying a two-sided document, then flip the original document, and then reload it faceup into the ADF or facedown on the scanner glass.

7 Remove the paper from the paper exit tray, and then reload the paper to print the other side of the document.



8 Press .

Canceling copy jobs

To cancel a copy job, press .

Scanning stops and the printer returns to the previous menu.

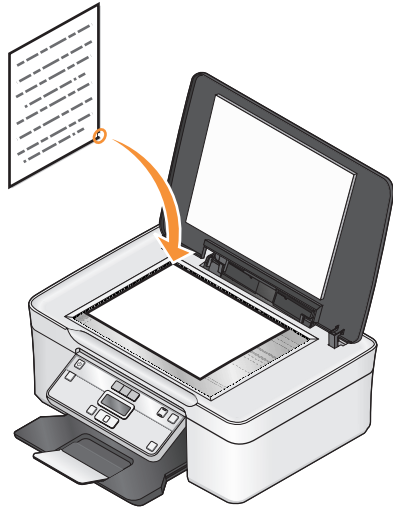

Scanning

Automatic Document Feeder (ADF)	Scanner glass
<p>Use the ADF for multiple-page documents.</p> <p>Note: The ADF is available only on selected models. If you purchased a printer without an ADF, then load original documents or photos on the scanner glass.</p>	 <p>Use the scanner glass for single pages, small items (such as postcards or photos), transparencies, photo paper, or thin media (such as magazine clippings).</p>

Tips for scanning

- When using the ADF, adjust the ADF paper guide to the width of the original document.
- When using the scanner glass, close the scanner lid to avoid dark edges on the scanned image.
- Do *not* load postcards, photos, small items, transparencies, photo paper, or thin media (such as magazine clippings) into the ADF. Place these items on the scanner glass.
- Select the PDF file type if you want to scan multiple pages and save them as one file.

Scanning to a local or network computer

- 1 Load an original document faceup into the ADF or facedown on the scanner glass.
 - 2 From the printer control panel, press .
 - 3 Press the arrow buttons to scroll to **Computer** or **Network**, and then press .
 - 4 Press the arrow buttons to select the name of a local or network computer, and then press .
- The local or network computer is the destination that will receive the scan.

Notes:

- You may be prompted to enter a PIN if the computer requires it. Enter the PIN using the keypad.
 - To assign a computer name and a PIN to the computer, see the Help for the printer software associated with your operating system.
- 5 Wait until the printer has finished downloading a list of the scan applications available on the selected computer.

- 6 Press the arrow buttons to select an application, and then press **OK**.
- 7 Press the arrow buttons to select the resolution quality and the original image size. Press **OK** each time you make a selection.
- 8 Press **▶** to start scanning.

The scan is complete when the application you selected in step 6 opens on the destination computer, and the scan appears within the application as a new file.

Scanning to a flash drive or memory card

Before you begin, make sure your flash drive or memory card is not write protected.

- 1 Load an original document faceup into the ADF or facedown on the scanner glass.
- 2 From the printer control panel, press **⏪**.
- 3 When **Scan to** appears on the display, insert the flash drive or memory card.
- 4 Press the arrow buttons to scroll to **USB Flash Drive** or **Memory Card**, and then press **OK**.
- 5 Press the arrow buttons to select the resolution quality, the type of output you want to create, and the original image size. Press **OK** each time you make a selection.
- 6 Press **▶** to start scanning.

The scan is complete when a message appears on the printer control panel indicating that the file you scanned has been saved.

Scanning photos into an editing application

Using the printer control panel

- 1 Load the photo or photos facedown on the scanner glass.
- 2 From the printer control panel, press **⏪**.
- 3 Press the arrow buttons to scroll to **Computer** or **Network**, and then press **OK**.
- 4 Press the arrow buttons to select the name of a local or network computer, and then press **OK**.
The local or network computer is the destination that will receive the scan.
- 5 Wait until the printer has finished downloading the list of scan applications available on the selected computer.
- 6 Press the arrow buttons to select a photo editing application, and then press **OK**.
- 7 Press the arrow buttons to select the resolution quality, the type of output you want to create, and the original image size. Press **OK** each time you make a selection.
- 8 Press **▶** to start scanning.
- 9 When asked if you want to scan another page, press **OK** to select **Yes**.
- 10 Load the next photo or photos facedown on the scanner glass, and then press **OK**.

11 Repeat steps 9 and 10 until all the photos that you want to scan are saved to the printer memory.

12 When asked if you want to scan another page, press the arrow buttons to scroll to **No**, and then press **OK**.

The scan is complete when the photo editing application you selected in step 6 opens on the destination computer, and the scan appears within the application as a new file.

Using the printer software

1 Load a photo or photos facedown on the scanner glass.

2 Click  or **Start**.

3 Click **All Programs** or **Programs**, and then select the printer program folder from the list.

4 Select **Printer Home**.

5 Choose your printer from the printer drop-down list.

6 Click **Photo**.

- If you want to scan a single photo, or multiple photos as a single image, then select **Single photo**.
- If you want to scan multiple photos at once and save them as separate images, then select **Split into individual photos**.

Scanning starts and the scan progress dialog appears.

7 Save the photo or photos and open in a photo editing application to edit.

Scanning documents into an editing application

An Optical Character Recognition (OCR) application allows you to edit an original text document that has been scanned. In order for this to work, you must have an OCR application stored on a local or network computer and you must be able to choose it from the list of applications when you set up the scan.

When selecting settings for the scan:

- Select to scan to the local computer or network computer where the OCR is installed.
- Select to scan to the highest resolution.

1 Load an original document faceup into the ADF or facedown on the scanner glass.

2 Click  or **Start**.

3 Click **All Programs** or **Programs**, and then select the printer program folder from the list.

4 Select **Printer Home**.

5 Choose your printer from the printer drop-down list.

6 Click **Document**.

Scanning starts and the scan progress dialog appears.

7 When the scan is finished, save the document in a word-processing application.

8 Open the document in the selected application to edit it.

Scanning directly to e-mail

- 1 Load an original document faceup into the ADF or facedown on the scanner glass.
- 2 Click  or **Start**.
- 3 Click **All Programs** or **Programs**, and then select the printer program folder from the list.
- 4 Select **Printer Home**.
- 5 Choose your printer from the printer drop-down list.
- 6 Click **Email**, and then select **Photo**, **Document** or **PDF**.
Scanning starts and the scan progress dialog appears.
- 7 When the scan is finished, a new e-mail message is created with the scanned document automatically attached.
- 8 Compose your e-mail message.

Note: If your e-mail program does not open automatically, then you can scan the document to the computer and then send it through e-mail as an attachment.

Scanning to a PDF

- 1 Load an original document faceup into the ADF or facedown on the scanner glass.
- 2 Click  or **Start**.
- 3 Click **All Programs** or **Programs**, and then select the printer program folder from the list.
- 4 Select **Printer Home**.
- 5 Choose your printer from the printer drop-down list.
- 6 Click **PDF**.
Scanning starts and the scan progress dialog appears.
- 7 Save the document as a PDF.

Scanning FAQ

How can I improve the quality of a scan?

- Make sure your original documents are in good condition.
- Make sure the application that receives the scanned document is appropriate. For example, if you are scanning a photo to edit it, then make sure you choose a photo editing application to receive the scan. If you are scanning a document to edit the text, then make sure you choose an OCR application.
- Use a high resolution.

How do I scan in black and white?

Color is the default for all scans. To scan in black and white, press the **Color/Black** button on the printer control panel to switch from color to black and white.

Why am I being asked for a PIN?



PINs are a security measure used to restrict the scanned information from going into certain locations, or to keep what is being scanned from being seen or used by others. You may be prompted to enter a PIN if the network computer you are scanning to requires one.

To learn how PINs get assigned to network computers, see the Help for the printer software associated with your operating system.

What is an application list, and how do I update it?

When you scan a file, you can choose which application to use to open it on your computer. The printer downloads this application list from your computer when scanning for the first time. If you do not see the application you want on the list, or if you install new applications on your computer, then update the application list in the printer.

Updating the application list

- 1 From the printer control panel, press .
- 2 Press the arrow buttons to scroll to **Computer** or **Network**.
- 3 Select a local or network computer to receive the scan and then press .
- 4 Select **REFRESH** from the list of scan applications.
This updates the application list in the printer.

Canceling scan jobs

Press  on the printer control panel, or click **Cancel** on the computer screen.

Networking

Installing the printer on a wireless network

Wireless network compatibility

Your printer contains an IEEE 802.11g wireless print server. Your printer is compatible with IEEE 802.11 b/g/n routers that are Wi-Fi certified. If you are having issues with an n router, verify with your router manufacturer that the current mode setting is compatible with g devices, as this setting varies depending on the router brand/model.

Supported network security options

The printer supports three wireless security options: no security, WEP, and WPA/WPA2.

No Security

It is not recommended to use no security at all on a home wireless network. Using no security means that anyone within range of your wireless network can use your network resources—including Internet access, if your wireless network is connected to the Internet. The range of your wireless network may extend far beyond the walls of your home, allowing access to your network from the street or from your neighbors' homes.

WEP

WEP (Wireless Equivalent Privacy) is the most basic and the weakest type of wireless security. WEP security relies on a series of characters called the WEP key.

Every device on the wireless network must use the same WEP key. WEP security can be used on both ad hoc and infrastructure networks.

A valid WEP key has:

- Exactly 10 or 26 hexadecimal characters. Hexadecimal characters are A–F, a–f, and 0–9
- or*
- Exactly 5 or 13 ASCII characters. ASCII characters are letters, numbers, punctuation, and symbols found on a keyboard.

WPA/WPA2

WPA (Wi-Fi Protected Access) and WPA2 (Wi-Fi Protected Access 2) offer stronger wireless network security than WEP. WPA and WPA2 are similar types of security. WPA2 uses a more complex encryption method and is more secure than WPA. Both WPA and WPA2 use a series of characters, called the WPA pre-shared key or passphrase, to protect wireless networks from unauthorized access.

A valid WPA passphrase has:



- From 8 to 63 ASCII characters. ASCII characters in a WPA passphrase are case-sensitive.
- or*
- Exactly 64 hexadecimal characters. Hexadecimal characters are A–F, a–f, and 0–9.

Every device on the wireless network must use the same WPA passphrase. WPA security is an option only on infrastructure networks with wireless access points and network cards that support WPA. Most newer wireless network equipment also offers WPA2 security as an option.

Note: If your network uses WPA or WPA2 security, then select **WPA Personal** when you are prompted to select the type of security your network uses.

Printing a network setup page

A *network setup page* lists the configuration settings of the printer, including the IP address and MAC address of the printer.

- 1 Load plain paper.
- 2 From the printer control panel, press .
- 3 Press the arrow buttons to scroll to **Network Setup**, and then press .
Print Network Setup Page appears.
- 4 Press  to print the network setup page.

Information you will need to set up the printer on a wireless network

To set up the printer for wireless printing, you need to know:

- The name of your wireless network. This is also known as the *Service Set Identifier (SSID)*.
- If encryption was used to secure your network.
- The security key (either a WEP key or WPA passphrase) that allows other devices to communicate on the network if encryption was used to secure your network.

You can locate your network WEP key or WPA passphrase by accessing your wireless access point or router and checking the security information.

If your wireless access point (wireless router) is using *Wired Equivalent Privacy (WEP)* security, the WEP key should be:

- Exactly 10 or 26 hexadecimal characters. Hexadecimal characters are A–F, a–f, and 0–9.
or
- Exactly 5 or 13 ASCII characters. ASCII characters are letters, numbers, punctuation, and symbols found on a keyboard.

If your wireless access point is using *Wi-Fi Protected Access (WPA)* security, the WPA passphrase should be:

- From 8 to 63 ASCII characters. ASCII characters in a WPA passphrase are case-sensitive.
or
- Exactly 64 hexadecimal characters. Hexadecimal characters are A–F, a–f, and 0–9.

If your wireless network is not using security, then you will not have a security key.

Note: If you do not know the SSID of the network that your computer is connected to, launch the wireless utility of the computer network adapter and look for the network name. If you cannot find the SSID or the security information for your network, see the documentation that came with the wireless access point, or contact your system support person.

Installing the printer on a wireless network

Before you install the printer on a wireless network, make sure that:

- Your wireless network is set up and working properly.
- The computer you are using is connected to the same wireless network where you want to set up the printer.

1 Close all open software programs.

2 Insert the installation software CD.

If the Welcome screen does not appear after a minute, then launch the CD manually:

- a** Click , or click **Start** and then click **Run**.
- b** In the Start Search or Run box, type `D:\setup.exe`, where **D** is the letter of your CD or DVD drive.

3 Follow the instructions on the Welcome screen to set up the printer.

Installing the printer on other computers

Once the printer is set up on the wireless network, it can be accessed wirelessly by any other computer on the network. However, you will need to install the printer driver on every computer that will access it. You do not need to configure the printer again, although you will need to run the setup software on each computer to install the driver.

1 Close all open software programs.

2 Insert the installation software CD.

If the Welcome screen does not appear after a minute, then launch the CD manually:

- a** Click , or click **Start** and then click **Run**.
- b** In the Start Search or Run box, type `D:\setup.exe`, where **D** is the letter of your CD or DVD drive.

3 Follow the instructions on the computer screen for installing a configured printer on a new computer.

Interpreting the colors of the Wi-Fi indicator light

The colors of the Wi-Fi indicator light show the network status of the printer.

- **Off** means one of the following:
 - The printer is turned off or is powering up.
 - The printer is not connected to a wireless network and is in Power Saver mode. In Power Saver mode, the power light pulses on and off.
- **Solid orange** means one of the following:
 - The printer has not yet been configured for a wireless network.
 - The printer is configured for an ad hoc connection, but it is not currently communicating with another ad hoc device.
- **Blinking orange** means one of the following:
 - The printer is out of the range of the wireless access point (wireless router).
 - The printer is trying to communicate with the wireless access point, but the wireless access point is turned off or not working properly.
 - Either the configured printer or the wireless access point has been turned off and back on, and the printer is trying to establish communications with the network.
 - The wireless settings of the printer may no longer be valid.
- **Green** means that the printer is connected to a wireless network and is ready for use.

Special wireless installation instructions

The following instructions apply to customers outside of North America who are using a wireless broadband box. Some examples of these boxes include LiveBox, AliceBox, N9UF Box, FreeBox, and Club Internet.

Before you begin

- Make sure your box is wireless-enabled and activated to work on a wireless network. For more information about configuring the box to work wirelessly, see the documentation that came with your box.
- Make sure your box is turned on and that your computer is on and connected to your wireless network.

Adding the printer to your wireless network

- 1** Set up your printer for wireless networking using the setup instructions provided.
Stop when you are prompted to select a network.
- 2** If there is an association/registration button on the back of your box, press it before selecting a network.

Note: After pressing the association/registration button, you have five minutes to complete the printer installation.

- 3** Return to the computer screen.

From the list that appears in the “Choose your wireless network” dialog, select your network, and then click **Continue**.

If your wireless network does not appear in the list:

- a** Select **Unlisted Network**, and then click **Continue**.
- b** Enter the details about your wireless network.

Note: Your WEP, WPA, or WPA2 key may be obtained from the bottom of the box, the user’s guide that came with the box, or from the box Web page. If you have already changed the key for your wireless network, use the key you created.

- 4** Follow the instructions on your screen to complete installation.

Assigning a static IP address

The printer will be assigned an IP address automatically through DHCP on most wireless networks.

If you want to assign a static IP address to your printer, do the following:

- 1** Complete the wireless setup, allowing the printer to receive a DHCP address from a DHCP server on the network.
- 2** Print a network setup page to see what IP address is currently assigned to the printer.
- 3** Open a Web browser and then type the printer IP address in the address field. Press **Enter**.
The printer Web page loads.
- 4** Click the **Configuration** link.
- 5** Click the **TCP/IP** link.
- 6** Click the **Set Static IP Address** link.

7 Type the IP address you want to assign to the printer in the **IP Address** field.

8 Click the **Submit** button.

The Submitting Selection message appears.

To confirm that the address was successfully assigned, type the static IP address in the Web browser address field and then press **Enter**. The printer Web page loads if the address was successfully assigned.

For more information, contact your system support person.

Changing wireless settings after installation

To change wireless settings on the printer, such as the configured network, the security key, or other settings, do the following:

- 1 Click  or **Start**.
- 2 Click **All Programs** or **Programs**, and then select the printer program folder from the list.
- 3 Select **Printer Home**.
- 4 Click the **Settings** tab.
- 5 Click the **Wireless setup utility** link.
- 6 Follow the instructions on the computer screen to configure the printer for wireless access with the new settings.

Advanced wireless setup

Creating an ad hoc wireless network

The recommended way to set up your wireless network is to use a wireless access point (wireless router). A network set up this way is called an *infrastructure network*. If you have an infrastructure network, you should configure the printer for use on that network.

Note: The printer can communicate on only one wireless network at a time. Configuring the printer for an ad hoc wireless network will keep it from working on any other wireless network, either ad hoc or infrastructure.

You can set up an ad hoc network if you:

- Do not have an access point or wireless router
- Do not already have a wireless network (but do have a wireless adapter for your computer)
- Want to set up a standalone network between the printer and a computer with a wireless network adapter

In Windows Vista

- 1 Click .
- 2 Click **Control Panel**.
- 3 Click **Network and Internet**.
- 4 Under Network and Sharing Center, click **Connect to a Network**.
- 5 In the Connect to a Network dialog, click **Set up a wireless ad-hoc (computer-to-computer) network**, and then click **Next**.

- 6 Follow the instructions in the “Set up a wireless ad hoc network” wizard. As part of the setup:
 - a Create a network name or SSID for the network between the computer and your printer.
 - b Write down the name of your network. Be sure to use the exact spelling and capitalization.
 - c Go to the Security Type list, select **WEP**, and then create a WEP key.

WEP keys must be:

- Exactly 10 or 26 hexadecimal characters. Hexadecimal characters are A-F, a-f, and 0-9.
or
- Exactly 5 or 13 ASCII characters. ASCII characters are letters, numbers, and symbols found on a keyboard

- d Write down the password for your network. Be sure to use the exact spelling and capitalization.

Windows Vista will enable the ad hoc network for you. It will appear in the “Connect to a network” dialog under “Available networks,” indicating that the computer is configured for the ad hoc network.

- 7 Close the Windows Control Panel and any remaining windows.
- 8 Insert the installation software CD, and follow the directions for wireless installation.
Note: Do not connect the installation or network cables until instructed to do so by the setup software.
- 9 When the available networks are displayed, provide the network name and the security information you created in step 6. The installer will configure the printer for use with your computer.
- 10 Store a copy of your network name and security information in a safe place for future reference.

In Windows XP

- 1 Click **Start**.
- 2 Click **Control Panel**.
- 3 Click **Network and Internet Connections**.
- 4 Click **Network Connections**.
- 5 Right-click the icon for your wireless network connection.
- 6 Click **Enable**, if it appears in the pop-up menu.
Note: If Disable appears, your wireless connection is already enabled.
- 7 Right-click the **Wireless Network Connection** icon.
- 8 Click **Properties**.
- 9 Click the **Wireless Networks** tab.
Note: If the Wireless Networks tab does not appear, your computer has third-party software that controls your wireless settings. You must use that software to set up the ad hoc wireless network. For more information, see the documentation for the third-party software to learn how to create an ad hoc network.
- 10 Select the **Use Windows to configure my wireless network settings** check box.
- 11 Under Preferred Networks, delete any existing networks.
 - a Select the network to be removed.
 - b Click **Remove** to delete the network from the list.
- 12 Click **Add** to create an ad hoc network.

- 13** In the Network Name (SSID) box, type the name you want to give your wireless network.
- 14** Write down the network name you chose so you can refer to it when running the wireless setup. Be sure to use the exact spelling and capitalization.
- 15** If Network Authentication appears in the list, select **Open**.
- 16** In the "Data encryption" list, select **WEP**.
- 17** If necessary, clear the "The key is provided for me automatically" check box.
- 18** In the Network Key box, type in a WEP key.
- 19** Write down the WEP key you chose so you can refer to it when running the wireless setup. Make sure you copy it down exactly, including any capital letters.
- 20** In the "Confirm network key" box, type the same WEP key.
- 21** Select **This is a computer-to-computer (ad hoc) network; wireless access points are not used**.
- 22** Click **OK** twice to close the two open windows.
- 23** It may take a few minutes for your computer to recognize the new settings. To check on the status of your network:
 - a** Right-click the **Wireless Network Connections** icon.
 - b** Select **View Available Wireless Networks**.
 - If the network is listed but the computer is not connected, select the ad hoc network and then click **Connect**.
 - If the network does not appear, wait a minute and then click **Refresh network list**.
- 24** Insert the installation software CD, and follow the directions for wireless installation.

Note: Do not connect the installation or network cables until instructed to do so by the setup software.
- 25** When the available networks are displayed, provide the network name and the security information you created beginning in step 13. The installer will configure the printer for use with your computer.
- 26** Store a copy of your network name and security information in a safe place for future reference.

In Windows 2000

- Refer to the documentation that came with your wireless network adapter for information on configuring an ad hoc network with Windows 2000.

Adding a printer to an existing ad hoc wireless network

Note: The printer can communicate on only one wireless network at a time. Configuring the printer for an ad hoc wireless network will remove it from any other wireless network, either ad hoc or infrastructure, for which it is configured.

- 1** Click  or **Start**.
- 2** Click **All Programs** or **Programs**, and then select the printer program folder from the list.
- 3** Select **Printer Home**.
- 4** Click the **Settings** tab.
- 5** Click **Wireless setup utility** link.
- 6** Follow the instructions on the computer screen.

Configuring the printer wirelessly using WPS (Wi-Fi Protected Setup)

Wi-Fi Protected Setup (WPS) is a method of configuring computers and printers on a secure wireless network. WPS is faster and eliminates typing errors when new devices are added to a wireless network. The SSID and WPA passphrase are automatically detected and configured for you. The printer supports WPS and can be configured for a wireless access using WPS. In order to use WPS to configure the printer, the wireless router must also support WPS.

If you want to use WPS to set up your printer, then insert the CD and follow the instructions on the computer screen.

Note: To use WPS to configure the printer wirelessly, all of the devices on your wireless network must support WPS. If any device on your network does not support WPS, then you must type the SSID and security information when prompted.

Switching between USB and wireless connections (Windows only)

You can change the way you access your printer, depending on your needs. The following procedures assume that you have configured your printer for one type of connection and that the printer drivers are installed on the computer. See related topics on troubleshooting specific connection types if you encounter difficulties during configuration.

Using the printer wirelessly

- 1 Click  or **Start**.
- 2 Click **All Programs** or **Programs**, and then select the printer program folder from the list.
- 3 Select **Printer Home**.
- 4 Click the **Settings** tab.
- 5 Click the **Wireless setup utility** link.
- 6 Follow the instructions on the computer screen to set up the printer wirelessly.

Note: There is no need to remove the USB cable connecting the printer to the computer during wireless configuration.

Using the printer locally (USB)

- 1 Attach a USB cable to the computer and to the printer.
- 2 Wait a moment for Windows to locate the driver and finish setting up the printer.

Note: You can continue to use the printer wirelessly.

Sharing a printer in a Windows environment

- 1 Prepare the computers to share the printer:
 - a Make all computers printing to the printer accessible through Network Neighborhood by enabling File and Print Sharing. See the Windows documentation for instructions on enabling File and Print Sharing.
 - b Install the printer software on all computers that will print to the printer.
- 2 Identify the printer:
 - a On the computer that is attached to the printer, do one of the following:
 - 1 Click , or click **Start** and then click **Run**.
 - 2 In the Start Search or Run box, type `control printers`.

Look for any of these identifier marks to check if your device is WPS certified:



You can find these WPS logos on the side, back, or top of your access point or router.

Where do I find my WEP key or WPA passphrase?

To find the WEP key or WPA passphrase for the wireless network, view the security settings on the access point or wireless router. Most access points have a Web page that can be accessed using a Web browser.

You can also check the manual that came with your access point or router. If your access point or router is using the default settings, you can find the information in the manual. If someone else set up your network for you, that person or company may have included the information in the manual.

If you do not know how to access the Web page, or if you do not have administrator access to the wireless access point on your network, and are unable to locate the information in the manual, contact your system support person.

What is an SSID?

A Service Set Identifier (SSID) is the name that identifies a wireless network. All devices on the network must know the SSID of the wireless network or they will not be able to communicate with each other. Usually, the wireless network broadcasts the SSID to allow wireless devices in the area to connect to it. Sometimes, the SSID is not broadcast for security reasons.

If the SSID of your wireless network is not broadcast, it cannot be detected automatically and will not show up in the list of available wireless networks. You must enter the network information manually in this situation.

An SSID can contain up to 32 alphanumeric characters.

Where do I find my SSID?

You can find the SSID for the wireless network by viewing the settings on the access point or wireless router. Most access points have a built-in Web server that can be accessed using a Web browser.

Many network adapters provide a software application that allows you to view the wireless settings of your computer, including your SSID. Check your computer to see if a program was installed with your network adapter.

If you are unable to locate your SSID using either of these methods, contact your system support person.

What is a network?

A network is a collection of devices such as computers, printers, Ethernet hubs, wireless access points, and routers connected together for communication through cables or through a wireless connection. A network can be wired, wireless, or designed to have both wired and wireless devices.

Devices on a wired network use cables to communicate with each other.

Devices on a wireless network use radio waves instead of cables to communicate with each other. For a device to be able to communicate wirelessly, it must have a wireless network adapter attached or installed that lets it receive and transmit radio waves.

How do I find out what type of security my network is using?

You must know the WEP key or WPA passphrase and the type of security (WEP, WPA, or WPA2) used on the wireless network. To obtain this information, see the documentation that came with your wireless access point (wireless router), see the Web page associated with the wireless access point, or consult your system support person.

Note: The WEP key or WPA passphrase is not the same as the password for the wireless access point. The password allows you to access the wireless access point settings. The WEP key or WPA passphrase allows printers and computers to join your wireless network.

How are home networks configured?

For desktop computers, laptops, and printers to communicate with each other over a network, they must be connected by cables and/or have wireless network adapters built in or installed in them.

There are many different ways a network can be set up. Four common examples appear below.

Note: The printers in the following diagrams represent printers with internal print servers built into them so that they can communicate over a network.

Wireless network examples

Scenario 1: Mixed wired and wireless connections on a network with Internet access

- All computers and printers connect to the network through a router with Ethernet and wireless capabilities.
- Some computers and printers connect wirelessly to the router; others connect over a wired connection.
- The network is connected to the Internet through a DSL or cable modem.

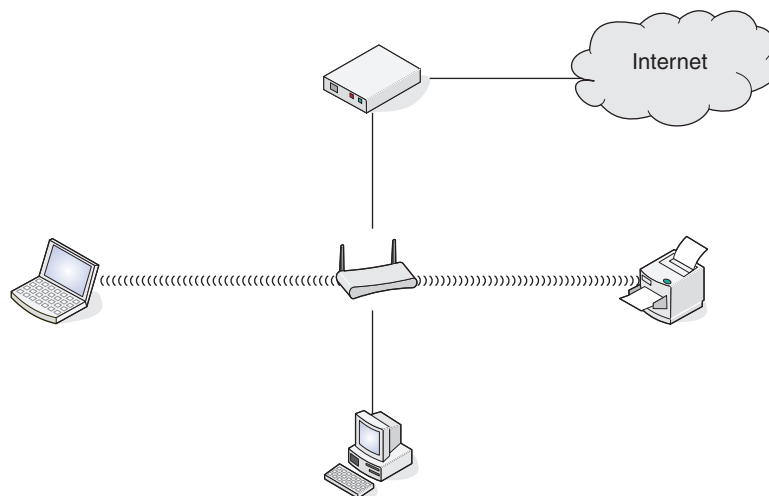

Scenario 2: Wireless network with Internet access

- All computers and printers connect to the network using a wireless access point or wireless router.
- The wireless access point connects the network to the Internet through a DSL or cable modem.

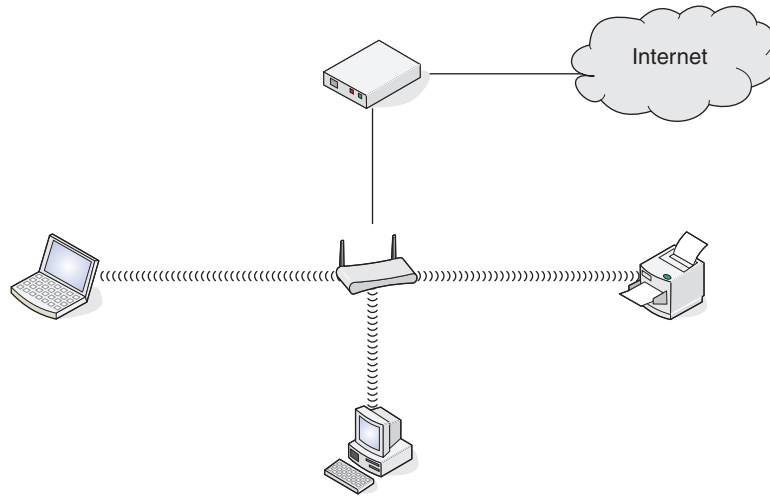

Scenario 3: Wireless network with no Internet access

- Computers and printers connect to the network using a wireless access point.
- The network has no connection to the Internet.

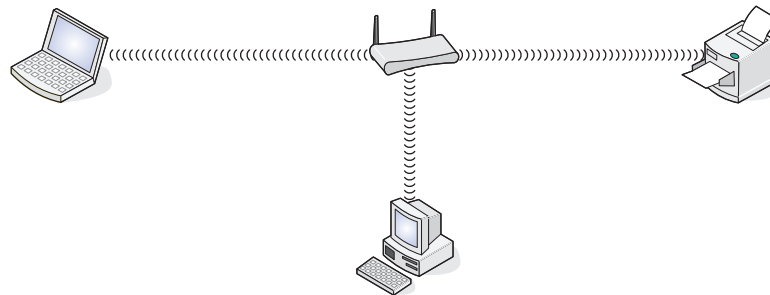

Scenario 4: Computer connected wirelessly to a printer without Internet access

- A computer is directly connected to a printer without going through a wireless router.
- This configuration is referred to as an *ad hoc network*.
- The network has no connection to the Internet.



Note: Most computers can connect to only one wireless network at a time. If you access the Internet over a wireless connection, you will lose Internet access if you are connected to an ad hoc network.

Why do I need an installation cable?

When setting up the printer on your wireless network, the printer will need to temporarily connect to a computer using the installation cable. This temporary connection is used to set up the wireless settings of the printer.

The installation cable connects to a rectangular USB port on the installing computer and the square USB port on the printer.

How do I attach the installation cable?

The installation cable attaches to a USB port on the computer and to the square connector on the back of the printer. This connection allows you to configure the printer for a networked or locally attached installation.

- 1 Attach the large, rectangular connector to any USB port on your computer. USB ports may be on the front or the back of the computer, and may be horizontal or vertical.

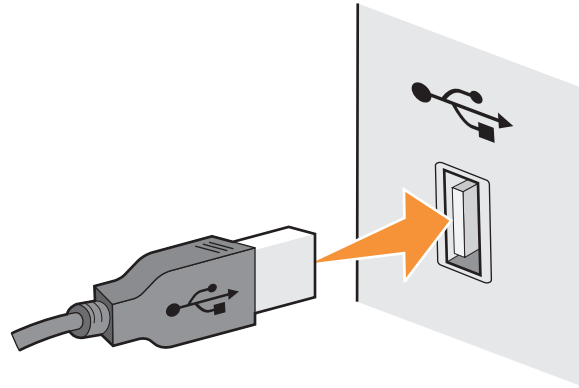

- 2 Attach the small, square connector to the printer.

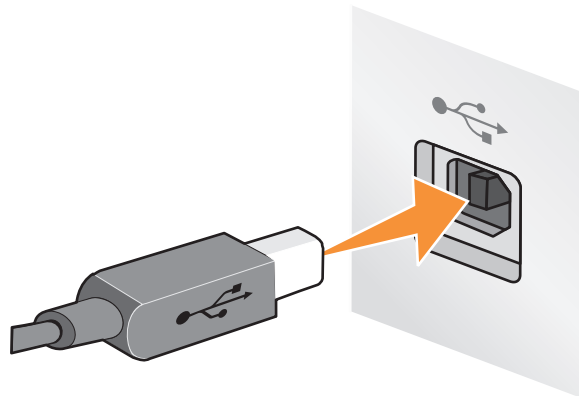

- 3 Continue following the on-screen instructions.

How are infrastructure and ad hoc networks different?

Wireless networks can operate in one of two modes: infrastructure or ad hoc.

In *infrastructure* mode, all devices on a wireless network communicate with each other through a wireless router (wireless access point). Devices on the wireless network must have valid IP addresses for the current network and share the same SSID and channel as the wireless access point.

In *ad hoc* mode, a computer with a wireless network adapter communicates directly with a printer equipped with a wireless print server. The computer must have a valid IP address for the current network and be set to ad hoc mode. The wireless print server must be configured to use the same SSID and channel that the computer is using.

The following table compares the characteristics and requirements of the two types of wireless networks.

	Infrastructure	Ad hoc
Characteristics		
Communication	Through wireless access point	Directly between devices
Security	More security options	WEP or no security
Range	Determined by range and number of wireless access points	Restricted to range of individual devices on network
Speed	Usually faster	Usually slower
Requirements for all devices		
Unique IP address for each device	Yes	Yes
Mode set to	Infrastructure mode	Ad hoc mode
Same SSID	Yes, including the wireless access point	Yes
Same channel	Yes, including the wireless access point	Yes

We recommend setting up a network in infrastructure mode using the installation CD that came with the printer.

Infrastructure mode is the recommended setup method because it provides:

- Increased network security
- Increased reliability
- Faster performance
- Easier setup

Finding the signal strength

Wireless devices have built-in antennas that transmit and receive radio signals. The signal strength listed on the printer network setup page indicates how strongly a transmitted signal is being received. Many factors can affect the signal strength. One factor is interference from other wireless devices or other devices such as microwave ovens. Another factor is distance. The farther two wireless devices are from each other, the more likely it is that the communication signal will be weaker.

The strength of the signal received by your computer can also affect the connectivity of the printer with the network during configuration. When you installed the wireless adapter in your computer, the adapter software probably placed an icon in your system tray. Try double-clicking this icon, and it will tell you how strongly the computer is receiving the wireless signal from the network.

To improve signal quality, remove sources of interference and/or move wireless devices closer to the wireless access point (wireless router).

How can I improve wireless signal strength?

A common reason wireless printers fail to communicate over a network is poor wireless signal quality. If the signal is too weak, too distorted, or blocked by an object, it cannot carry information between the access point and the printer. To determine if the printer is receiving a strong signal from the access point, print a network setup page. The Quality field indicates the relative strength of the wireless signal the printer is receiving. Drops in signal strength can be intermittent, however, and although the signal quality appears high, it may drop during certain conditions.

If you think signal strength is a problem between your access point and the printer, try one or more of the following:

Notes:

- The solutions below are for infrastructure networks. If you are using an ad hoc network, adjust the computer when the solution suggests adjusting the access point.
- Ad hoc networks have a much shorter range than infrastructure networks. Try moving the printer closer to the computer if they seem to have trouble communicating.

MOVE THE PRINTER CLOSER TO THE WIRELESS ACCESS POINT/WIRELESS ROUTER

If the printer is too far away from the access point, it will not be able to communicate with other devices on the network. For most indoor wireless networks, the maximum distance between the access point and the printer is approximately 100 feet (30 meters). This distance could be longer or shorter, depending upon the layout of the network and the limitations of the access point.

REMOVE OBSTACLES BETWEEN THE ACCESS POINT AND THE PRINTER

The wireless signal from your access point will pass through most objects. Most walls, floors, furniture and other objects will not block the wireless signal. However, there are materials that are too dense for the signal to pass through. Objects containing metal and concrete can block the signal. Arrange your printer and access point so that the signal is not blocked by such objects.

REMOVE SOURCES OF INTERFERENCE

Other types of radio frequencies can cause problems with the wireless signal on your network. These sources of interference can cause printing issues that seem to come and go. Turn off potential sources of interference where possible. Avoid using microwaves and cordless phones when printing over your wireless network.

If another wireless network is operating in the vicinity, change the wireless channel on the access point.

Do not place your access point on a printer or other electronic device. Such devices can also interfere with the wireless signal.

ARRANGE THE NETWORK TO REDUCE SIGNAL ABSORPTION

Even when the wireless signal is able to pass through an object, it is slightly weakened. If it passes through too many objects, it can be significantly weakened. All objects absorb part of the wireless signal when it passes through them, and certain types of objects absorb enough to cause communications problems. Place your access point as high in the room as possible to avoid signal absorption.

How can I make sure my computer and printer are connected to the same wireless network?

If the printer is not on the same wireless network as the computer, you will not be able to print wirelessly. The SSID of the printer must match the SSID of the computer, if the computer is already connected to the wireless network.

- 1** Obtain the SSID of the network that the computer is connected to:
 - a** Type the IP address of your wireless access point (wireless router) into the address field of your Web browser.
If you do not know the IP address of the wireless access point:
 - 1** Click , or click **Start** and then click **Run**.
 - 2** In the Start Search or Run box, type `cmd`.
 - 3** Press **Enter**, or click **OK**.
The Command Prompt window opens.
 - 4** Type `ipconfig`, and then press **Enter**. Check the Wireless Network Connection section:
 - The “Default Gateway” entry is typically the wireless access point.
 - The IP address appears as four sets of numbers separated by periods, such as 192.168.2.134.
 - b** Type the user name and password of the router when prompted.
 - c** Click **OK**.
 - d** On the main page, click **Wireless** or any other selection where settings are stored. The SSID will be displayed.
 - e** Write down the SSID.

Note: Make sure you copy it exactly, including any capital letters.

- 2** Print the printer network setup page.
In the Wireless section, look for **SSID**.
- 3** Compare the SSID of the computer and SSID of the printer.
If the SSIDs are the same, then the computer and the printer are connected to the same wireless network.
If the SSIDs are not the same, then run the utility again to set up the printer on the wireless network used by the computer.

Can I use my printer on a USB and a network connection at the same time?

Yes, the printer supports a simultaneous USB and network connection. The printer can be configured in the following ways:

- Locally attached (connected to a computer using a USB cable)
- Wireless network
- Wireless network and locally attached simultaneously

What is a MAC address?

A Media Access Control (MAC) address is a 48-bit identifier associated with the hardware of network equipment. The MAC address may also be called the physical address because it is connected to the hardware of a device instead of its software. The MAC address is displayed as a hexadecimal number in this format: 01-23-45-67-89-AB.

Every device capable of communicating on a network has a MAC address. Network printers, computers, and routers, whether Ethernet or wireless, all have MAC addresses.

While it is possible to change the MAC address of a network device, it is not common practice to do so. For this reason, MAC addresses are considered permanent. IP addresses are easily changed, so MAC addresses are a more reliable method of identifying a specific device on a network.

Routers with security capabilities may allow filtering of MAC addresses on networks. This allows a managed list of devices to access the network, identified by their MAC addresses. MAC address filtering can help prevent access on the network from unwanted devices, such as from intruders on a wireless network. MAC address filtering can also prevent legitimate access if you forget to add a new device to the router's list of allowed addresses. If your network uses MAC address filtering, be sure to add the MAC address of the printer to the list of allowed devices.

How do I find the MAC address?

Most network equipment has a unique hardware identification number to distinguish it from other devices on the network. This is called the *Media Access Control (MAC)* address.

When installing the printer on a network, make sure you select the printer with the correct MAC address.

The MAC address label is located inside the printer.

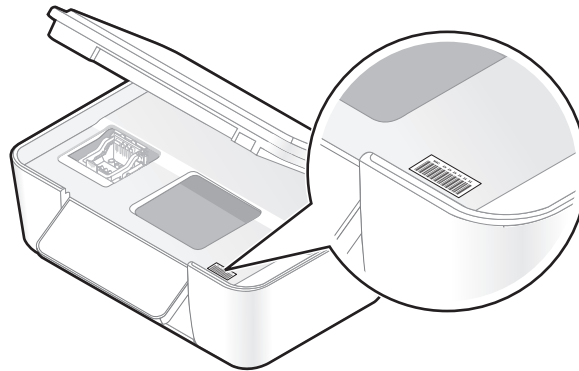

The MAC address of the internal print server is a series of letters and numbers. Other devices sometimes use a type of MAC address called *Universally Administered Address (UAA)*.



Note: A list of MAC addresses can be set on an access point (router) so that only devices with matching MAC addresses are allowed to operate on the network. This is called *MAC filtering*. If MAC filtering is enabled in your access point and you want to add a printer to your network, then the MAC address of the printer must be included in the MAC filter list.

What is an IP address?

An IP address is a unique number used by devices (such as a wireless printer, computer, or wireless access point) on an IP network to locate and communicate with each other. Devices on an IP network can communicate with each other only if they have unique and valid IP addresses. A unique IP address means no two devices on the same network have the same IP address.

An IP address is a group of four numbers separated by periods. An example of an IP address is 192.168.100.110.

What is TCP/IP?

Networks are able to function because computers, printers, and other devices are able to send data to each other, either through cables or by using wireless signals. This transfer of data is made possible by sets of data transmission rules called *protocols*. A protocol can be thought of as a language, and like a language, it has rules allowing participants to communicate with each other.

Different types of networks use different protocols, but *Transmission Control Protocol/Internet Protocol* (TCP/IP) is the most popular. TCP/IP is used to send data over the Internet as well as over most corporate and home networks.

Because computers do not understand words and instead rely upon numbers for communication, TCP/IP requires that every device on a network using TCP/IP to communicate must have an IP address. IP addresses are essentially unique computer names in a numeric format, used to transfer data around a network. IP addresses allow TCP/IP to confirm requests for and receipt of data by various devices on the network.

How do I locate IP addresses?

1 Click , or click **Start** and then click **Run**.

2 In the Start Search or Run box, type `cmd`.

3 Press **Enter**, or click **OK**.

The Command Prompt window opens.

4 Type `ipconfig`, and then press **Enter**.

The IP address appears as four sets of numbers separated by periods, such as 192.168.0.100.

How to locate a printer IP address

- You can locate the printer IP address by viewing the printer network setup page.

How are IP addresses assigned?

An IP address may be assigned automatically by the network using DHCP. Once the printer is set up on a computer, the computer sends all print jobs across the network to the printer using this address.

If the IP address is not automatically assigned, you will be asked during wireless setup to manually enter an address and other network information after selecting your printer from the available list.

What is a key index?

A wireless access point (wireless router) can be configured with as many as four WEP keys. Only one key is used on the network at a time, however. The keys are numbered, and the number of a key is referred to as its key index. All devices on the wireless network must be configured to use the same key index when multiple WEP keys are configured on the wireless access point.

Select the same key index on your printer as you are using on your wireless access point.

Maintaining the printer

Maintaining ink cartridges

Checking ink levels

Using the printer control panel

- 1 From the printer control panel, press .
- 2 Press the arrow buttons to scroll to **Maintenance**, and then press .
- 3 Press again to select **Ink Levels**.
- 4 Press the arrow buttons to check the ink level in each cartridge.

Using the printer software

- 1 Click  or **Start**.
- 2 Click **All Programs** or **Programs**, and then select the printer program folder from the list.
- 3 Select **Printer Home**.
- 4 Choose your printer from the printer drop-down list.
- 5 From the Maintenance tab, click **Check ink levels**.

Aligning the printhead

If the characters or lines on your printer image appear jagged or wavy, then you may need to align the printhead.

Using the printer control panel

- 1 Load plain paper.
- 2 From the printer control panel, press .
- 3 Press the arrow buttons to scroll to **Maintenance**, and then press .
- 4 Press the arrow buttons to scroll to **Align Printer**, and then press .
- 5 Press again.

An alignment page prints.

Note: Do not remove the alignment page until printing is finished.

Using the printer software

- 1 Load plain paper.
- 2 Click  or **Start**.
- 3 Click **All Programs** or **Programs**, and then select the printer program folder from the list.

- 4 Select **Printer Home**.
- 5 Choose your printer from the printer drop-down list.
- 6 From the Maintenance tab, click **Align cartridges**.
- 7 Follow the instructions on the computer screen.

If you aligned the cartridges to improve print quality, then print your document again. If print quality has not improved, then clean the printhead nozzles.

Cleaning the printhead nozzles

Poor print quality is sometimes due to clogged printhead nozzles. Clean the printhead nozzles to improve the quality of your prints.

Notes:

- Cleaning the printhead nozzles uses ink, so clean them only when necessary.
- Deep cleaning uses more ink, so try the Clean Printhead option first to save ink.
- If the ink levels are too low, you must replace the ink cartridges before you can clean the printhead nozzles.

Using the printer control panel

- 1 From the printer control panel, press .
- 2 Press the arrow buttons to scroll to **Maintenance**, and then press **OK**.
- 3 Press the arrow buttons to scroll to **Clean Printhead** or **Deep Clean Printhead**, and then press **OK**.
- 4 Press **OK** to clean the printhead nozzles.
A cleaning page prints.

Using the printer software

- 1 Click  or **Start**.
- 2 Click **All Programs** or **Programs**, and then select the printer program folder from the list.
- 3 Select **Printer Home**.
- 4 From the Maintenance tab, click **Clean Cartridges**.

Cleaning the exterior of the printer

- 1 Make sure that the printer is turned off and unplugged from the wall outlet.



CAUTION—SHOCK HAZARD: To avoid the risk of electric shock when cleaning the exterior of the printer, unplug the power cord from the wall outlet and disconnect all cables to the printer before proceeding.

- 2 Remove paper from the paper support and paper exit tray.
- 3 Dampen a clean, lint-free cloth with water.

Warning—Potential Damage: Do not use household cleaners or detergents, as they may damage the finish of the printer.

4 Wipe only the outside of the printer, making sure to remove any ink residue that has accumulated on the paper exit tray.

Warning—Potential Damage: Using a damp cloth to clean the interior may cause damage to your printer.

5 Make sure the paper support and paper exit tray are dry before beginning a new print job.

Cleaning the scanner glass

1 Dampen a clean, lint-free cloth with water.

2 Gently wipe the scanner glass clean.

Note: Make sure all ink or corrective fluid on a document is dry before placing the document on the scanner glass.

Troubleshooting

Before you troubleshoot

Use this checklist to solve most printer problems:

- Make sure the power cord is plugged into the printer and into a working electrical outlet.
- Make sure the printer is not plugged into any surge protectors, uninterrupted power supplies, or extension cords.
- Make sure the printer is turned on.
- Make sure the printer is securely connected to the host computer, print server, or other network access point.
- Check the printer for error messages, and resolve any errors.
- Check for paper jam messages, and clear any jams.
- Check the ink cartridges, and install new cartridges if necessary.
- Use the Service Center to locate and solve the problem (Windows only).
- Turn the printer off, wait about 10 seconds, and then turn the printer back on.

Using the Service Center to solve printer problems

The Service Center provides step-by-step troubleshooting help and contains links to printer maintenance tasks and customer support.

To open the Service Center, use one of these methods:

Method 1	Method 2
If it appears on an error message dialog, click the For additional assistance, use the Service Center link.	<ol style="list-style-type: none">1 Click  or Start.2 Click All Programs or Programs, and then select the printer program folder from the list.3 Select Printer Home.4 From the Support tab, select Service Center.

If Troubleshooting does not solve your problem

Visit our Web site at support.dell.com to find the following:

- Live online technical support
- Contact numbers for telephone technical support

Setup troubleshooting





- “Incorrect language appears on the display” on page 77
- “Printhead error” on page 77
- “Software did not install” on page 78
- “Print job does not print or is missing pages” on page 79

- "Printer is printing blank pages" on page 80
- "Printer is busy or does not respond" on page 80
- "Cannot delete documents from the print queue" on page 81
- "Cannot print through USB" on page 81



Incorrect language appears on the display

If the "Before you troubleshoot" checklist does not solve the problem, then try one or more of the following:

CHANGE THE LANGUAGE USING THE PRINTER MENUS

- 1 From the printer control panel, press .
- 2 Press the arrow buttons to scroll to **Defaults**, and then press .
- 3 Press the arrow buttons to scroll to **Set Defaults**, and then press .
- 4 Press the arrow buttons to scroll to **Use Factory**, and then press .
- 5 Complete the initial printer setup.

CHANGE THE LANGUAGE USING A BUTTON COMBINATION (IF YOU CANNOT READ THE CURRENT LANGUAGE)

- 1 Turn the printer off.
- 2 Press and hold down  and , and then press  to turn the printer on.
The printer resets and starts the initial printer setup.
- 3 Complete the initial printer setup.

Printhead error

If the "Before you troubleshoot" checklist does not solve the problem, then try the following:

REMOVE AND REINSERT THE PRINTHEAD

- 1 Open the printer and lift the latch.

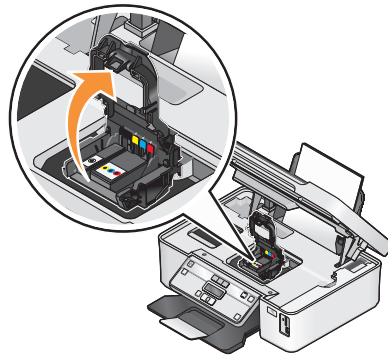

2 Remove the printhead.

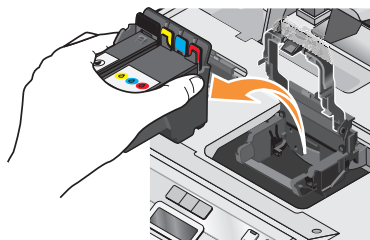

3 Wipe the printhead contacts using a clean, lint-free cloth.

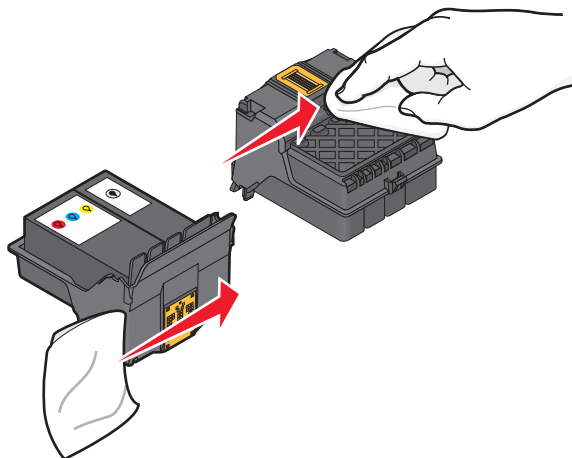

4 Reinsert the printhead.

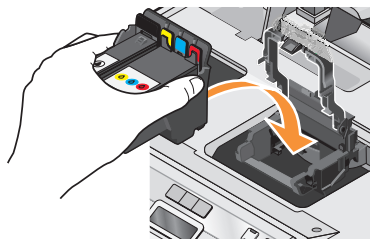

Note: If removing and reinserting the printhead does not resolve the error, then contact technical support.

Software did not install

If you encountered problems while installing, or if your printer does not appear in the list in the Printers folder or as a printer option when sending a print job, then try removing and reinstalling the software.

Before you reinstall the software, do the following:

MAKE SURE THAT YOUR COMPUTER MEETS THE MINIMUM SYSTEM REQUIREMENTS LISTED ON THE PRINTER BOX

TEMPORARILY DISABLE SECURITY PROGRAMS IN WINDOWS BEFORE INSTALLING THE SOFTWARE

CHECK THE USB CONNECTION

- 1 Check the USB cable for any obvious damage. If the cable is damaged, then use a new one.
- 2 Firmly plug the square end of the USB cable into the back of the printer.
- 3 Firmly plug the rectangular end of the USB cable into the USB port of the computer.

The USB port is marked with a  USB symbol.

RECONNECT THE PRINTER POWER SUPPLY

- 1 Turn off the printer, and then unplug the power cord from the wall outlet.
- 2 Gently remove the power supply from the printer, and then reinsert it.
- 3 Plug the power cord into the wall outlet, and then turn on the printer.

Print job does not print or is missing pages

If the "Before you troubleshoot" checklist does not solve the problem, then try one or more of the following:

MAKE SURE THE INK CARTRIDGES ARE INSERTED CORRECTLY

- 1 Turn the printer on, and then open the printer.
- 2 Make sure the cartridges are inserted correctly.
The cartridges should *click* firmly into the matching color slot of the printhead.
- 3 Close the printer.

SELECT YOUR PRINTER FROM THE PRINT DIALOG BEFORE SENDING THE PRINT JOB

MAKE SURE THE PRINT JOB IS NOT PAUSED

MAKE SURE YOUR PRINTER IS SET AS THE DEFAULT PRINTER

RECONNECT THE PRINTER POWER SUPPLY

- 1 Turn off the printer, and then unplug the power cord from the wall outlet.
- 2 Gently remove the power supply from the printer, and then reinsert it.
- 3 Plug the power cord into the wall outlet, and then turn on the printer.

REMOVE AND RECONNECT THE USB CABLE CONNECTED TO YOUR PRINTER

CHECK THE USB CONNECTION

- 1 Check the USB cable for any obvious damage. If the cable is damaged, then use a new one.
- 2 Firmly plug the square end of the USB cable into the back of the printer.





- 3 Firmly plug the rectangular end of the USB cable into the USB port of the computer.
The USB port is marked with a  USB symbol.

REMOVE AND REINSTALL THE PRINTER SOFTWARE

Printer is printing blank pages

Blank pages may be caused by improperly installed ink cartridges.

REINSTALL THE INK CARTRIDGES AND DEEP CLEAN AND ALIGN THE PRINTHEAD

- 1 Reinstall the ink cartridges, see “Replacing ink cartridges” on page 13 for more information.
If the cartridges do not seem to fit, make sure the printhead is properly seated, and then try installing the cartridges again.
 - 2 Load plain paper.
 - 3 From the printer control panel, press .
 - 4 Press the arrow buttons to scroll to **Maintenance**, and then press .
 - 5 Press the arrow buttons to scroll to **Deep Clean Printhead**, and then press .
 - A cleaning page prints.
 - 6 Press the arrow buttons to scroll to **Align Printer**, and then press .
 - An alignment page prints.
- Note:** Do not remove the alignment page until printing is finished.

Printer is busy or does not respond

If the "Before you troubleshoot" checklist does not solve the problem, then try one or more of the following:

MAKE SURE THE PRINTER IS NOT IN POWER SAVER MODE

If the power light is blinking on and off slowly, then the printer is in Power Saver mode. Press  to wake up the printer.

If the printer will not come out of Power Saver mode, then reset the power:

- 1 Unplug the power cord from the wall outlet, and then wait 10 seconds.
- 2 Insert the power cord into the wall outlet, and then turn on the printer.

If this problem persists, then check our Web site for updates for your printer software or firmware.

RECONNECT THE PRINTER POWER SUPPLY

- 1 Turn off the printer, and then unplug the power cord from the wall outlet.
- 2 Gently remove the power supply from the printer, and then reinsert it.
- 3 Plug the power cord into the wall outlet, and then turn on the printer.

Cannot delete documents from the print queue

If you have jobs stuck in the print queue and cannot delete them to get other jobs to print, then the computer and printer may not be communicating.

RESTART THE COMPUTER AND TRY AGAIN

Cannot print through USB

If the "Before you troubleshoot" checklist does not solve the problem, then try one or more of the following:

CHECK THE USB CONNECTION

- 1 Check the USB cable for any obvious damage. If the cable is damaged, then use a new one.
- 2 Firmly plug the square end of the USB cable into the back of the printer.
- 3 Firmly plug the rectangular end of the USB cable into the USB port of the computer.
The USB port is marked with a  USB symbol.

MAKE SURE THE USB PORT IS ENABLED IN WINDOWS

- 1 Click , or click **Start** and then click **Run**.
- 2 In the Start Search or Run box, type `devmgmt.msc`.
- 3 Press **Enter**, or click **OK**.
The Device Manager opens.
- 4 Click the plus sign (+) beside Universal Serial Bus controllers.
If USB Host Controller and USB Root Hub are listed, then the USB port is enabled.

For more information, see the computer documentation.

REMOVE AND REINSTALL THE PRINTER SOFTWARE

Jams and misfeeds troubleshooting

- "Paper jam in the printer" on page 81
- "Paper jam in the paper support" on page 82
- "Paper or specialty media misfeeds" on page 82

Paper jam in the printer

Note: The parts inside the printer are sensitive. Avoid unnecessarily touching these parts while clearing jams.

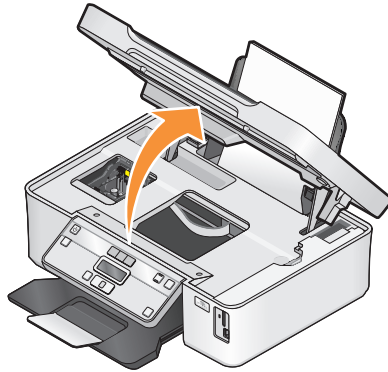

- 1 Press  to turn off the printer.
- 2 Check the paper tray or lift the scanner unit to check for jammed paper.



- 3 Firmly grasp the paper, and then gently pull it out.
Note: Be careful not to tear the paper while removing it.
- 4 Press  to turn the printer back on.

Paper jam in the paper support

Note: The parts inside the printer are sensitive. Avoid unnecessarily touching these parts while clearing jams.

- 1 Press  to turn off the printer.
- 2 Firmly grasp the paper, and then gently pull it out.
Note: Be careful not to tear the paper while removing it.
- 3 Press  to turn the printer back on.

Paper or specialty media misfeeds

These are possible solutions if paper or specialty media misfeeds or skews, or if multiple sheets feed or stick together. Try one or more of the following:

CHECK PAPER CONDITION

Use only new, unwrinkled paper.

CHECK PAPER LOADING

- Load a smaller amount of paper into the printer.
- Load paper with the print side faceup. (If you are not sure which side is the printable side, see the instructions that came with the paper.)
- Check the loading instructions for your paper or specialty media.

REMOVE EACH PAGE AS IT IS PRINTED

ADJUST THE PAPER GUIDES TO FIT THE LOADED PAPER

Print troubleshooting

- “Poor quality at the edges of the page” on page 83
- “Streaks or lines on printed image” on page 83
- “Print speed is slow” on page 84
- “Computer slows down when printing” on page 84

Poor quality at the edges of the page

If the "Before you troubleshoot" checklist does not solve the problem, then try one or more of the following:

CHECK MINIMUM PRINT SETTINGS

Unless you are using the borderless feature, use these minimum print margin settings:

- Left and right margins:
 - 6.35 mm (0.25 in.) for letter-size paper
 - 3.37 mm (0.133 in.) for all paper sizes except letter
- Top margin: 1.7 mm (0.067 in.)
- Bottom margin: 12.7 mm (0.5 in.)

SELECT THE BORDERLESS PRINT FEATURE

- 1 With a document or photo open, click **File → Print**.
- 2 Click **Properties, Preferences, Options, or Setup**.
- 3 From the Paper Options section of the Print Setup tab, select **Borderless**.

Streaks or lines on printed image

If the "Before you troubleshoot" checklist does not solve the problem, then try one or more of the following:

CHECK THE INK LEVELS

Replace low or empty ink cartridges.

SELECT A HIGHER PRINT QUALITY FROM THE PRINTER SOFTWARE

MAKE SURE THE INK CARTRIDGES ARE PROPERLY INSTALLED

ALIGN THE PRINTHEAD

CLEAN OR DEEP CLEAN THE PRINTHEAD NOZZLES

Note: If these solutions do not remove the streaks or lines on the printed image, then contact technical support.

Print speed is slow

If the "Before you troubleshoot" checklist does not solve the problem, then try one or more of the following:

MAXIMIZE COMPUTER PROCESSING SPEED

- Close all applications not in use.
- Minimize the number and size of graphics and images in the document.
- Remove as many unused fonts as possible from your system.

ADD MEMORY

Consider purchasing more RAM.

SELECT A LOWER PRINT QUALITY FROM THE PRINTER SOFTWARE

MANUALLY SELECT A PAPER TYPE THAT MATCHES THE TYPE OF PAPER YOU ARE USING

REMOVE AND REINSTALL THE PRINTER SOFTWARE

Computer slows down when printing

These are possible solutions. Try one of the following:

IF YOU ARE USING A USB CONNECTION, THEN TRY A DIFFERENT USB CABLE

IF YOU ARE ON A NETWORK, THEN RESET THE POWER OF THE ACCESS POINT (ROUTER)

- 1 Unplug the power cord from the access point.
- 2 Wait ten seconds, and then insert the power cord.

Copy and scan troubleshooting

- "Copier or scanner does not respond" on page 85
- "Scanner unit does not close" on page 85
- "Poor copy or scanned image quality" on page 85
- "Partial copies or scans of documents or photos" on page 85
- "Scan was not successful" on page 86
- "Scanning takes too long or freezes the computer" on page 86
- "Cannot scan to a computer over a network" on page 86

Copier or scanner does not respond

If the "Before you troubleshoot" checklist does not solve the problem, then try one or more of the following:

SET YOUR PRINTER AS THE DEFAULT PRINTER

REMOVE AND REINSTALL THE PRINTER SOFTWARE

Scanner unit does not close

- 1 Lift the scanner unit.
- 2 Remove any obstruction keeping the scanner unit open.
- 3 Lower the scanner unit.

Poor copy or scanned image quality

If the "Before you troubleshoot" checklist does not solve the problem, then try one or more of the following:

CLEAN THE SCANNER GLASS

ADJUST THE SCAN QUALITY FROM THE PRINTER SOFTWARE

REVIEW THE TIPS FOR COPYING, SCANNING, AND IMPROVING PRINT QUALITY

USE A CLEARER VERSION OF THE ORIGINAL DOCUMENT OR IMAGE

MAKE SURE THE DOCUMENT OR PHOTO IS LOADED FACEDOWN ON THE SCANNER GLASS AND IN THE CORRECT CORNER

Partial copies or scans of documents or photos

If the "Before you troubleshoot" checklist does not solve the problem, then try one or more of the following:

MAKE SURE THE DOCUMENT OR PHOTO IS LOADED FACEDOWN ON THE SCANNER GLASS AND IN THE CORRECT CORNER

SELECT A PAPER SIZE FROM THE PRINTER SOFTWARE THAT MATCHES THE LOADED PAPER

MAKE SURE THE ORIGINAL SIZE SETTING MATCHES THE SIZE OF THE DOCUMENT YOU ARE SCANNING

Scan was not successful

If the "Before you troubleshoot" checklist does not solve the problem, then try one or more of the following:

CHECK THE USB CONNECTION

- 1 Check the USB cable for any obvious damage. If the cable is damaged, then use a new one.
- 2 Firmly plug the square end of the USB cable into the back of the printer.
- 3 Firmly plug the rectangular end of the USB cable into the USB port of the computer.
The USB port is marked with a  USB symbol.

RESTART THE COMPUTER

Scanning takes too long or freezes the computer

If the "Before you troubleshoot" checklist does not solve the problem, then try one or more of the following:

CLOSE OTHER SOFTWARE PROGRAMS THAT ARE NOT BEING USED

USE A LOWER SCANNING RESOLUTION

Cannot scan to a computer over a network

If the "Before you troubleshoot" checklist does not solve the problem, then try one or more of the following:

MAKE SURE THE PRINTER AND THE DESTINATION COMPUTER ARE CONNECTED TO THE SAME NETWORK

MAKE SURE THE PRINTER SOFTWARE IS INSTALLED ON THE DESTINATION COMPUTER

Memory card troubleshooting

- "Memory card troubleshooting checklist" on page 86
- "Nothing happens when a memory card is inserted" on page 87
- "Cannot print documents from a memory card or flash drive" on page 87
- "Photos do not transfer from a memory card across a wireless network" on page 87

Memory card troubleshooting checklist

Before you troubleshoot, use the following checklist to solve most memory card problems:

- Make sure that the memory card you are using can be used in the printer.
- Make sure you insert the memory card into the correct slot.
- Make sure the memory card is not damaged.
- Make sure memory card contains supported file types.

Nothing happens when a memory card is inserted

If the "Memory card troubleshooting checklist" does not solve the problem, then try one or more of the following:

REINSERT THE MEMORY CARD

The memory card may have been inserted too slowly. Remove and then reinsert the memory card quickly.

CHECK THE USB CONNECTION

- 1 Check the USB cable for any obvious damage. If the cable is damaged, then use a new one.
- 2 Firmly plug the square end of the USB cable into the back of the printer.
- 3 Firmly plug the rectangular end of the USB cable into the USB port of the computer.

The USB port is marked with a  USB symbol.

CHECK THE NETWORK CONNECTION

If the printer and computer are connected over a network, then make sure that the correct host and device are communicating. Select the printer from the computer or the computer from the printer.

Cannot print documents from a memory card or flash drive

If the "Memory card troubleshooting checklist" does not solve the problem, then try the following:

CHECK THE USB CONNECTION

- 1 Check the USB cable for any obvious damage. If the cable is damaged, then use a new one.
- 2 Firmly plug the square end of the USB cable into the back of the printer.
- 3 Firmly plug the rectangular end of the USB cable into the USB port of the computer.

The USB port is marked with a  USB symbol.

CHECK THE NETWORK CONNECTION

If the printer and computer are connected over a network, then make sure that the correct host and device are communicating. Select the printer from the computer or the computer from the printer.

Photos do not transfer from a memory card across a wireless network

If the "Memory card troubleshooting checklist" does not solve the problem, then try one or more of the following:

MAKE SURE THAT BOTH THE PRINTER AND THE DESTINATION COMPUTER ARE TURNED ON AND READY

SET YOUR PRINTER AS THE DEFAULT PRINTER FROM THE DESTINATION COMPUTER

SELECT THE CORRECT COMPUTER NAME FROM THE SCAN DESTINATION LIST ON THE PRINTER

MAKE SURE YOUR WIRELESS NETWORK IS CONNECTED AND ACTIVE

If your wireless connection is down, then use a USB cable to connect your printer to your computer.

Wireless troubleshooting

- “Wireless troubleshooting checklist” on page 88
- “Resetting the wireless settings to factory defaults” on page 89
- “Cannot print over wireless network” on page 89
- “The Continue button is unavailable” on page 91
- “Cannot print and there is a firewall on the computer” on page 92
- “Wi-Fi indicator light is not lit” on page 93
- “Wi-Fi indicator light is green but the printer does not print (Windows only)” on page 93
- “Wi-Fi indicator light is still orange” on page 94
- “Wi-Fi indicator light is blinking orange during installation” on page 95
- “Wireless print server not installed” on page 98
- ““Communication not available” message displays when printing wirelessly” on page 98
- “Communication with printer lost when connected to Virtual Private Network (VPN)” on page 100
- “Resolving intermittent wireless communications issues” on page 100





Wireless troubleshooting checklist

Before beginning to troubleshoot the wireless printer, verify the following:

- The printer, the computer, and the wireless access point are all plugged in and turned on.
- The wireless network is working properly.
Try accessing other computers on your wireless network.
If your network has Internet access, try connecting to the Internet over a wireless connection.
- Your SSID is correct.
Print a network setup page to verify the SSID the printer is using.
If you are not sure if your SSID is correct, then run the wireless setup again.
- Your WEP key or WPA passphrase is correct (if your network is secure).
Log into the wireless access point (wireless router) and check the security settings.
A security key is like a password. All devices on the same wireless network using WEP, WPA, or WPA2 share the same security key.
If you are not sure if your security information is correct, run the wireless setup again.
- The printer and the computer are within the range of the wireless network.
For most networks, the printer and the computer should be within 100 feet (30 meters) of the wireless access point (wireless router).
- The Wi-Fi indicator light is lit and is solid green.
- The printer driver is installed on the computer from which you are performing a task.

- The correct printer port is selected.
- The computer and printer are both connected to the same wireless network.
- The printer is located away from obstacles or electronic devices that could interfere with the wireless signal.
Make sure the printer and wireless access point are not separated by poles, walls, or support columns containing metal or concrete.
Many devices can interfere with the wireless signal, including baby monitors, motors, cordless phones, security system cameras, other wireless networks, and some Bluetooth devices.

Resetting the wireless settings to factory defaults

- 1 From the printer control panel, press .
- 2 Press the arrow buttons to scroll to **Network Setup**, and then press .
- 3 Press the arrow buttons to scroll to **Reset Network Adapter to Factory Defaults**, and then press .
- 4 Press the arrow buttons to scroll to **Yes**, and then press .

The printer wireless settings are reset to factory default settings. To verify, print a network setup page.

Cannot print over wireless network

If you encountered problems while installing, or if your printer does not appear in the printers folder or as a printer option when sending a print job, then you can try uninstalling and reinstalling the software.

Before you reinstall the software, check the troubleshooting checklist, and then do the following:

MAKE SURE YOUR COMPUTER IS CONNECTED TO YOUR WIRELESS ACCESS POINT (WIRELESS ROUTER)

- See if you have access to the Internet by opening your Web browser and accessing any site.
- If there are other computers or resources on your wireless network, then check to see if you can access them from your computer.

MOVE THE COMPUTER AND/OR PRINTER CLOSER TO THE WIRELESS ROUTER

Although the possible distance between devices in 802.11b or 802.11g networks is 300 feet, the maximum range for optimal performance is generally 100-150 feet.

MOVE YOUR ACCESS POINT AWAY FROM OTHER ELECTRONIC DEVICES

There may be temporary interference from electronic devices such as microwave ovens or other appliances, cordless phones, baby monitors, and security system cameras. Make sure your access point is not positioned too closely to these devices.

MAKE SURE THAT YOUR COMPUTER AND PRINTER ARE CONNECTED TO THE SAME WIRELESS NETWORK

If the printer is not on the same wireless network as the computer, you will not be able to print wirelessly. The SSID of the printer must match the SSID of the computer, if the computer is already connected to the wireless network.

- 1 Obtain the SSID of the network that the computer is connected to.
 - a Type the IP address of your wireless access point (wireless router) into the address field of your Web browser.

If you do not know the IP address of the wireless access point:

 - 1 Click , or click **Start** and then click **Run**.
 - 2 In the Start Search or Run box, type **cmd**.
 - 3 Press **Enter** or click **OK**.

The Command Prompt window opens.
 - 4 Type **ipconfig**, and then press **Enter**. Check the Wireless Network Connection section:
 - The “Default Gateway” entry is typically the wireless access point .
 - The IP address appears as four sets of numbers separated by periods, such as 192.168.2.134.
 - b Type the user name and password of the router when prompted.
 - c Click **OK**.
 - d On the main page, click **Wireless** or any other selection where settings are stored. The SSID will be displayed.
 - e Write down the SSID.

Note: Make sure you copy it exactly, including any capital letters.

- 2 Print the printer network setup page.

In the Wireless section, look for **SSID**.
- 3 Compare the SSID of the computer and SSID of the printer.

If the SSIDs are the same, then the computer and the printer are connected to the same wireless network.

If the SSIDs are not the same, then run the utility again to set up the printer on the wireless network used by the computer.

CHECK YOUR WEP KEY OR WPA PASSPHRASE

If your wireless access point is using Wireless Equivalent Privacy (WEP) security, then the WEP key should be:

- Exactly 10 or 26 hexadecimal characters. Hexadecimal characters are A–F, a–f, and 0–9.

or
- Exactly 5 or 13 ASCII characters. ASCII characters are letters, numbers, and symbols found on a keyboard. ASCII characters in a WEP key are case-sensitive.

If your wireless access point is using Wi-Fi Protected Access (WPA) security, then the WPA passphrase should be:

- From 8 to 63 ASCII characters. ASCII characters in a WPA passphrase are case-sensitive.

or
- Exactly 64 hexadecimal characters. Hexadecimal characters are A–F, a–f, and 0–9.

Note: If you do not know this information, then see the documentation that came with the wireless network, or contact the person who set up your wireless network.

DISCONNECT FROM VPN SESSION

When you are connected to another network through a VPN connection, you will not be able to access the printer over your wireless network. End your VPN session and try printing again.

CHECK YOUR ADVANCED SECURITY SETTINGS

- If you are using MAC address filtering to limit access to your wireless network, then you must add the printer MAC address to the list of addresses allowed to connect to the wireless access point.
- If you set the wireless access point to issue a limited number of IP addresses, then you must change this so that the printer can be added.

Note: If you do not know how to make these changes, then see the documentation that came with the wireless network, or contact the person who set up your wireless network.

The Continue button is unavailable

Try the following solutions in the order they appear until the Continue button becomes active and can be clicked:

CHECK IF THE USB CABLE IS SECURELY PLUGGED INTO THE USB PORTS ON BOTH THE COMPUTER AND THE PRINTER

USB ports are marked with the  symbol.

MAKE SURE THAT THE PRINTER IS PLUGGED IN AND TURNED ON

Check to see if the  button is lit. If you have just turned on the printer, then you might need to disconnect the USB cable and reconnect it.

MAKE SURE THAT THE USB PORT ON THE COMPUTER IS WORKING

Test the USB port by connecting other devices to it. If you can successfully use other devices from the port, then the port is working.

If the USB port on the computer is not working, then try using the other USB ports on the computer.

MAKE SURE THAT THE USB CABLE IS WORKING

Try using a different USB cable. If you are using a cable longer than 10 feet, then try using a shorter cable.

MAKE SURE THAT YOU ARE USING THE CORRECT CD FOR YOUR PRINTER MODEL

Compare the printer model on the CD to the printer model on the printer. The numbers should either match exactly or be within the same series.

If you have any doubts, look for an updated version of the printer software on our Web site. For more information, see "Installing the printer software" in the *User's Guide*. You can access the *User's Guide* from the link at the bottom of the installation screen.

RECONNECT THE POWER SUPPLY

- 1 Turn off the printer.
- 2 Unplug the power cord from the power outlet.
- 3 Remove the power supply from the back of the printer and then plug it back in.

- 4 Plug the power cord back into the power outlet.
- 5 Turn on the printer, and then resume the installation on your computer.

TRY RUNNING THE INSTALLER AGAIN

- 1 Close the installer.
- 2 Remove the CD, and then restart the computer.
- 3 Insert the CD and then run the installer again.

Notes:

- When you get to the **Software Already Installed** screen, make sure you select **Install a printer**.
- If you have already set up your printer, select **Additional Computer** when you get to the **Setting up a new printer?** screen to skip the hardware setup wizard.

CHECK THAT YOUR COMPUTER IS ABLE TO ACKNOWLEDGE USB ACTIVITY ON THE USB PORT

Open the Device Manager to check if it has activity whenever a USB device is connected to a USB port:

- 1 Click , or click **Start** and then click **Run**.
- 2 In the Start Search or Run box, type `devmgmt.msc`.
- 3 Press **Enter**, or click **OK**.

The Device Manager opens.

- 4 Watch the Device Manager window while connecting a USB cable or another device to the USB port. The window refreshes when Device Manager recognizes the USB connection.
 - If there is activity on Device Manager but none of the previous solutions worked, call Customer Support.
 - If there is no activity on Device Manager, there may be a problem with your computer and its USB support. The computer must recognize the USB connection in order for installation to work.

Cannot print and there is a firewall on the computer

Third-party (non-Microsoft) firewalls can interfere with wireless printing. If the printer and computer are configured correctly, and the wireless network is working, but the printer will not print wirelessly, then a firewall could be the problem. If there is a firewall (other than the Windows firewall) on the computer, try one or more of the following:

- Update the firewall using the most recent update available from the manufacturer. Refer to the documentation that came with your firewall for instructions on how to do this.
- If programs request firewall access when you install the printer or try to print, make sure you allow those programs to run.
- Temporarily disable the firewall and install the wireless printer on the computer. Re-enable the firewall when you have completed the wireless installation.

Wi-Fi indicator light is not lit

CHECK POWER

If the Wi-Fi indicator light is off, make sure the  light is on. If the  light is not on, check the following:

- Make sure the printer is plugged in and turned on.
- Make sure the printer is plugged into a working outlet.
- If the printer is plugged into a power strip, make sure it is turned on and working.

Wi-Fi indicator light is green but the printer does not print (Windows only)

If you have completed the configuration for wireless printing and all of the settings appear to be correct, but the printer does not print, then try one or more of the following:

ALLOW THE WIRELESS INSTALLATION TO COMPLETE

Do not attempt to print, remove the installation CD, or detach the installation cable until you see the Wireless Setup Successful screen.

ENABLE THE PRINTER

Confirm that the printer is enabled:

- 1 Click , or click **Start** and then click **Run**.
- 2 In the Start Search or Run box, type `control printers`.
- 3 Press **Enter**, or click **OK**.
The printer folder opens.
- 4 Right-click the new printer; from the menu, select **Use Printer Online**.
- 5 Close the Printers or Printers and Faxes window and try printing again.

SELECT THE WIRELESS PRINTER

You may need to select the wireless printer from your computer to use the printer wirelessly.

- 1 Click , or click **Start** and then click **Run**.
- 2 In the Start Search or Run box, type `control printers`.
- 3 Press **Enter**, or click **OK**.
The printer folder opens.
- 4 Right-click the printer in the folder with the matching name and model number followed by "(Network)."
- 5 Select **Use Printer Online** from the menu.
- 6 Close the Printers or Printers and Faxes window and try printing again.

SELECT THE WIRELESS PORT

If you have previously set up your printer as a locally attached printer, then you may need to select the wireless printer to use the printer wirelessly.

- 1 Click , or click **Start** and then click **Run**.
- 2 In the Start Search or Run box, type `control printers`.
- 3 Press **Enter**, or click **OK**.
The printer folder opens.
- 4 Right-click the printer, and then select **Properties** from the menu.
- 5 Click the **Ports** tab.
- 6 Locate the selected port. The selected port has a check beside it in the Port column.
- 7 If the Description column of the selected port indicates that it is a USB port, scroll through the list and select the port with Printer Port in the Description column. Check the printer model in the Printer column to make sure you select the right printer port.
- 8 Click **OK**, and then try to print again.

Wi-Fi indicator light is still orange

When the Wi-Fi indicator light is orange, it may indicate that the printer is:

- Not configured in infrastructure mode
- Waiting to make an ad hoc connection to another wireless device

The printer may be unable to join the network because of interference, its distance from the wireless access point (wireless router), or until its settings are changed.

These are possible solutions. Try one or more of the following:

CHECK NETWORK NAME

Make sure your network does not have the same name as another network near you. For example, if you and your neighbor both use a manufacturer's default network name, your printer could be connecting to your neighbor's network.

If you are not using a unique network name, consult the documentation for your wireless access point (wireless router) to learn how to set a network name.

If you set a new network name, you must reset the printer and computer SSID to the same network name.

CHECK SECURITY KEYS

If you are using WEP security

A valid WEP key is:

- Exactly 10 or 26 hexadecimal characters. Hexadecimal characters are A–F, a–f, and 0–9.
or
- Exactly 5 or 13 ASCII characters. ASCII characters are letters, numbers, and symbols found on a keyboard.

If you are using WPA security

A valid WPA passphrase is:

- From 8 to 63 ASCII characters. ASCII characters in a WPA passphrase are case-sensitive.
or
- Exactly 64 hexadecimal characters. Hexadecimal characters are A-F, a-f, and 0-9.

If your wireless network is not using security, then you will not have a security key. Using a wireless network with no security is not recommended because it can allow intruders to use your network resources without your consent.

MOVE YOUR PRINTER

Move the printer closer to the wireless access point (wireless router). Although the possible distance between devices in 802.11b or 802.11g networks is 300 feet, the maximum range for optimal performance is generally 100-150 feet.

You can find the strength of the network signal on the printer network setup page.

CHECK MAC ADDRESS

If your network uses MAC address filtering, make sure that you include the MAC address of the printer in the MAC address filter list. This will allow the printer to operate on the network.

Wi-Fi indicator light is blinking orange during installation

When the Wi-Fi indicator light is blinking orange, it indicates that the printer has been set up for wireless networking but cannot connect to the network for which it has been configured. The printer may be unable to join the network because of interference, its distance from the wireless access point (wireless router), or until its settings are changed.

These are possible solutions. Try one or more of the following:

MAKE SURE THE ACCESS POINT IS ON

Check the access point and, if necessary, turn it on.

MOVE YOUR ACCESS POINT TO MINIMIZE INTERFERENCE

There may be temporary interference from other devices such as microwave ovens or other appliances, cordless phones, baby monitors, and security system cameras. Make sure your access point is not positioned too closely to these devices.

MOVE THE COMPUTER AND/OR PRINTER CLOSER TO THE WIRELESS ACCESS POINT (WIRELESS ROUTER)

Move the computer and/or printer closer to the access point. Although the possible distance between devices in 802.11b or 802.11g networks is 300 feet, the maximum range for optimal performance is generally 100–150 feet.

You can find the signal strength of the network on the network setup page.

CHECK YOUR WEP KEY OR WPA PASSPHRASE

A WEP key or WPA passphrase is like a password. All devices on a WEP-secured wireless network must share the same WEP key, and all devices on a WPA-secured wireless network must share the same WPA passphrase.

Note: Make sure you copy it exactly, including any capital letters, and store it in a safe place for future reference.

If you are using WEP security

A valid WEP key is:

- Exactly 10 or 26 hexadecimal characters. Hexadecimal characters are A–F, a–f, and 0–9.
or
- Exactly 5 or 13 ASCII characters. ASCII characters are letters, numbers, and symbols found on a keyboard.

If you are using WPA security

A valid WPA passphrase is:



- From 8 to 63 ASCII characters. ASCII characters in a WPA passphrase are case-sensitive.
or
- Exactly 64 hexadecimal characters. Hexadecimal characters are A–F, a–f, and 0–9.

If your wireless network is not using security, then you will not have a security key. Using a wireless network with no security is not recommended because it can allow intruders to use your network resources without your consent.

CHECK MAC ADDRESS

If your network uses MAC address filtering, make sure that you include the MAC address of the printer in the MAC address filter list. This will allow the printer to operate on the network. For more information, see “How do I find the MAC address?” on page 71.

PING THE ACCESS POINT TO MAKE SURE THE NETWORK IS WORKING

- 1 If you do not already know it, find the IP address of the access point:
 - a Click , or click **Start** and then click **Run**.
 - b In the Start Search or Run box, type `cmd`.
 - c Press **Enter**, or click **OK**.
The Command Prompt window opens.
 - d Type `ipconfig`, and then press **Enter**.
 - The “Default Gateway” entry is typically the wireless access point.
 - The IP address appears as four sets of numbers separated by periods, such as 192.168.2.134.
- 2 Ping the access point:
 - a Click , or click **Start** and then click **Run**.
 - b In the Start Search or Run box, type `cmd`.
 - c Press **Enter**, or click **OK**.
The Command Prompt window opens.

d Type `ping` followed by a space and the IP address of the wireless access point. For example:
`ping 192.168.1.100`

e Press **Enter**.

3 Check to see whether the access point responds:

- If the access point responds, you will see several lines appear that start with “Reply from.” It is possible that the printer did not connect to the wireless network. Turn off and then restart the printer to try to connect again.
- If the access point does not respond, it will take several seconds and then you will see “Request timed out.”

Try the following:

a Click , or click **Start** and then click **Run**.

b In the Start Search or Run box, type `ncpa.cpl`, and then press **Enter**.

c Press **Enter** or click **OK**.

d Select the appropriate connection from the ones shown.

e Right-click the connection, and then click **Repair**.

MAKE SURE YOUR COMPUTER CAN COMMUNICATE WITH THE PRINTER

1 Obtain the printer IP address by printing a network setup page.

2 Click , or click **Start** and then click **Run**.

3 In the Start Search or Run box, type `cmd`.

4 Press **Enter**, or click **OK**.

The Command Prompt window opens.

5 Type `ping` followed by a space and the IP address of the printer. For example:

```
ping 192.168.1.100
```

6 Press **Enter**.

7 If the printer responds, you will see several lines that display the number of bytes received from the printer. This ensures that your computer is communicating with your printer.

If the printer does not respond, then “Request timed out” displays.

- Your computer might not be connected to the network.
- You may need to change the settings of your printer. Run the Wireless Setup Utility again.

CONFIGURE THE PRINTER FOR WIRELESS ACCESS AGAIN

If your wireless settings have changed, you must run the printer wireless setup again. Some reasons your settings may have changed include your having manually changed your WEP or WPA keys, channel, or other network settings; or the access point having been reset to factory defaults.

Running the wireless setup again can also resolve issues due to misconfigurations that occurred when configuring the printer for wireless access.

Notes:

- If you change network settings, change them on all the network devices before changing them for the access point.
- If you have already changed the wireless network settings on your access point, then you must change the settings on all the other network devices before you can see them on the network.

- 1 Click  or **Start**.
- 2 Click **All Programs** or **Programs**, and then select the printer program folder from the list.
- 3 Select **Printer Home**.
- 4 Click the **Settings** tab.
- 5 Click the **Wireless setup utility** link.

Note: You may be prompted to connect the printer to the computer again using the installation cable as part of the setup process.

- 6 Follow the instructions on the computer screen.

Wireless print server not installed

You may see a message during installation indicating that the printer does not have a wireless print server installed. If you are sure the printer is capable of wireless printing, try the following:

CHECK POWER

Make sure the  light is on.

“Communication not available” message displays when printing wirelessly

These are possible solutions. Try one or more of the following:

MAKE SURE YOUR COMPUTER AND PRINTER HAVE VALID IP ADDRESSES FOR THE NETWORK

If you are using a laptop and have power saving settings enabled, you may see the **Communication not available** message on your computer screen when you attempt to print wirelessly. This can occur if the laptop hard drive has powered down.

If you see this message, wait a few seconds and then try to print again. The laptop and printer require a few seconds to power up again and reattach to the wireless network.

If you see this message again after you have waited long enough for the printer and the laptop to attach to the network, there may be a problem with your wireless network.

Make sure that the laptop and printer have both received IP addresses:

- 1 Click , or click **Start** and then click **Run**.
- 2 In the Start Search or Run box, type **cmd**.

- 3 Press **Enter**, or click **OK**.

The Command Prompt window opens.

- 4 Type `ipconfig`, and then press **Enter**.

The IP address appears as four sets of numbers separated by periods, such as 192.168.0.100.

How to locate a printer IP address

- You can locate the printer IP address by viewing the printer network setup page.

If the printer and/or the laptop does not have an IP address, or if either has an address of 169.254.x.y (where x and y are any two numbers between 0 and 255):

- 1 Turn off the device that does not have a valid IP address (the laptop, the printer, or both).
- 2 Turn on the device(s).
- 3 Check the IP addresses again.

If the laptop and/or printer still does not receive a valid IP address, there is a problem with your wireless network. Try the following:

- Make sure your wireless access point (wireless router) is turned on and is working.
- Remove any objects that could be blocking the signal.
- Temporarily turn off any unnecessary wireless devices on your network and pause any network-intensive activities, like large file transfers or network games. If the network is too busy, it is possible that the printer is not receiving the IP address within the allowed time.
- Make sure your DHCP server, which may also be your wireless router, is working and is configured to assign IP addresses. If you are not sure how to do this, refer to the manual that came with your wireless router for more information.

If the printer and computer have valid IP addresses and the network is operation correctly, continue troubleshooting.

MAKE SURE THE WIRELESS PORT IS SELECTED

- 1 Click , or click **Start** and then click **Run**.
- 2 In the Start Search or Run box, type `control printers`.
- 3 Press **Enter**, or click **OK**.
The printer folder opens.
- 4 Right-click the printer, and then select **Properties** from the menu.
- 5 Click the **Ports** tab.
- 6 Locate the selected port. The selected port has a check beside it in the Port column.
- 7 If the Description column of the selected port indicates that it is a USB port, scroll through the list and select the port with Printer Port in the Description column. Check the printer model in the Printer column to make sure you select the right printer port.
- 8 Click **OK**, and then try to print again.

MAKE SURE BIDIRECTIONAL COMMUNICATION IS ENABLED

- 1 Click , or click **Start** and then click **Run**.
- 2 In the Start Search or Run box, type `control printers`.
- 3 Press **Enter**, or click **OK**.
The printer folder opens.
- 4 Right-click the printer, and then select **Properties** from the menu.
- 5 Click the **Ports** tab.
- 6 Click the box next to **Enable bidirectional support** if it is not already checked.
- 7 Click **Apply**.
- 8 Click **OK**, and then try to print again.

Communication with printer lost when connected to Virtual Private Network (VPN)

You will lose your connection to a wireless printer on your local network when connected to most *Virtual Private Networks* (VPNs). Most VPNs allow users to communicate with only the VPN and no other network at the same time. If you would like to have the ability to connect to your local network and to a VPN at the same time, the system support person for the VPN must enable split tunneling. Be aware that some organizations will not allow split tunneling due to security or technical concerns.

Resolving intermittent wireless communications issues

You may notice that your printer works for a short time and then stops working, although apparently nothing has changed on your wireless network.

Many different issues can interrupt network communications, and sometimes more than one problem exists at the same time. These are possible solutions. Try one or more of the following:

DISCONNECT FROM ALL VPNS WHEN ATTEMPTING TO USE THE WIRELESS NETWORK

Most Virtual Private Networks (VPNs) allow computers to communicate with only the VPN and no other network at the same time. Disconnect from the VPN before installing the driver on the computer or before running the wireless setup on the computer.

To check if the computer is currently connected to a VPN, open your VPN Client software and check your VPN connections. If you do not have a VPN Client software installed, check the connections manually using the Windows VPN Client.

If you would like to have the ability to connect to your local network and to a VPN at the same time, the system support person for the VPN must enable split tunneling. Be aware that some organizations will not allow split tunneling due to security or technical concerns.

TURN OFF THE WIRELESS ACCESS POINT (WIRELESS ROUTER) AND TURN IT BACK ON AGAIN

ELIMINATE NETWORK CONGESTION

If a wireless network is too busy, the computer and printer may have difficulty communicating with each other. Some causes of wireless network congestion can include:

- Transferring large files across the network
- Networked games
- Peer-to-peer file swapping applications
- Streaming video
- Too many computers on the wireless network at once

ELIMINATE SOURCES OF INTERFERENCE

Common household items can potentially disrupt wireless network communications. Cordless phones (but not cellular phones), microwave ovens, baby monitors, almost any kitchen appliance, wireless surveillance equipment, nearby wireless networks, and any appliance containing a motor can disrupt wireless network communications.

Try turning on any potential sources of interference and see if it causes the problem. If it does, separate your wireless network from the device.

CHANGE THE CHANNEL THE WIRELESS ROUTER USES

You can sometimes eliminate interference from unknown sources by changing the channel your wireless router uses to broadcast. There are three distinct channels on a router. Check the documentation that came with your router to determine which three apply. Other channels are offered as options, but these overlap. If the router is configured to use the default settings, change the channel setting to use a different distinct channel. Refer to the manual that came with your wireless router if you are not sure how to change the channel.

CONFIGURE THE WIRELESS ROUTER WITH A UNIQUE SSID

Many wireless networks use the SSID that the router was originally configured by the manufacturer to use. Using the default SSID can cause problems when more than one network is operating in the same area with the same SSID. The printer or computer may attempt to attach to the wrong network, although it will appear to be trying to connect to the correct network.

To avoid this type of interference, change the SSID on your wireless router from the default. Refer to the manual that came with your router if you are not sure how to change the SSID.

Note: You must change the SSID on all of the other devices that access your wireless network if you change the SSID on the router.

ASSIGN STATIC IP ADDRESSES TO ALL DEVICES IN THE NETWORK

Most wireless networks use a DHCP server (dynamic host configuration protocol) built in to the wireless router to assign IP addresses to clients on the wireless network. DHCP addresses are assigned when they are needed, as when a new device is added to the wireless network or when it is powered on. Wireless devices must send a request to the router, and receive an IP address in response so they can function on the network. Because the router performs many other tasks besides assigning addresses, it sometimes does not respond quickly enough with an address. The requesting device sometimes gives up before it receives an address.

Try assigning static IP addresses to the devices in your network to resolve this issue. Static IP addresses cut down on the work your wireless router has to do. Refer to the manual that came with your router and your operating system documentation if you are not sure how to assign static IP addresses.

To assign a static IP address to the printer, do the following:

- 1** Complete the wireless setup, allowing the printer to receive a DHCP address from a DHCP server on the network.
- 2** Print a network setup page to see what IP address is currently assigned to the printer.
- 3** Open a Web browser and then type the printer IP address in the address field. Press **Enter**.
The printer Web page loads.
- 4** Click the **Configuration** link.
- 5** Click the **TCP/IP** link.
- 6** Click the **Set Static IP Address** link.
- 7** Type the IP address you want to assign to the printer in the **IP Address** field.
- 8** Click the **Submit** button.
The Submitting Selection message appears.

Confirm that the IP address is updated by typing the static IP address in the browser address field and checking to see if the printer Web page reloads.

CHECK FOR KNOWN ISSUES WITH THE WIRELESS ROUTER

Some wireless routers have documented defects that were identified and resolved by the manufacturers. Visit the company Web site of the router manufacturer. Check for firmware updates and other advice from the manufacturer. Check the manual that came with your wireless router if you are not sure how to reach the manufacturer Web site.

CHECK FOR WIRELESS ADAPTER UPDATES

If you are having trouble printing from one particular computer, check the Web site of the manufacturer of the network adapter card in that computer. It is possible that there is an updated driver available that could resolve the issue.

CHANGE ALL NETWORK DEVICES TO THE SAME TYPE

While it is possible to successfully mix 802.11b, 802.11g, and 802.11n devices on the same wireless network, the faster devices will sometimes prevent the slower devices from communicating. Wireless devices are designed to wait for a gap in wireless network communications before attempting to send information. If newer, faster devices are constantly using the wireless network, then older, slower devices will not have a chance to send data.

Try only turning on the network devices of the same type and see if network communications improve. If this solves the problem, you may want to upgrade your older devices with newer network adapters.

PURCHASE A NEW ROUTER

If your router is several years old, it may not be fully compatible with the newer wireless devices on your network. Consider purchasing a newer router that is fully compliant with the 802.11 IEEE specifications.

Index

A

- ad hoc
 - SSID 59
 - WEP 59
- ad hoc network 67
- ad hoc wireless network
 - adding a printer 61
 - creating using Windows 59
- additional computers
 - installing wireless printer 57
- AliceBox 58
- aligning the printhead 73
- appliances
 - wireless network 69
- application list
 - downloading 54
 - updating 54
- assigning IP address 72

B

- banner paper 27
- bidirectional communication
 - enabling 98
- black and white scanning 53
- Bluetooth
 - printing 42
 - setting the security level 42
 - setting up a connection 40
- buttons, printer control panel
 - Back 17
 - Cancel 17
 - Color/Black 16
 - Copy 16
 - Display 17
 - Photo 16
 - Power 16
 - Scan 16
 - Select 17
 - Settings 17
 - Start 16

C

- cable
 - installation 66, 67
 - USB 67
- camera
 - connecting 38

- canceling
 - copy job 49
 - print job 44
 - scan job 54
- cannot delete documents from print queue 81
- cannot print from a flash drive 87
- cannot print over wireless network 89
- cannot print through USB 81
- cannot scan to computer over a network 86
- changing Power Saver timeout 20
- changing printing mode 43
- changing temporary settings into default 19
- changing wireless settings after installation (Windows) 59
- checking an unresponsive printer 76
- checking ink levels 73
- checklist
 - before you troubleshoot 76
 - memory card troubleshooting 86
- cleaning exterior of the printer 74
- cleaning printhead nozzles 74
- Club Internet 58
- collating copies 47
- Communication not available message 98
- computer slows down when printing 84
- configuring
 - IP address 58
- connection
 - configurations 70
- conserving energy, ink, and paper 8
- conserving paper
 - using Eco-Mode 21
- continue button greyed out 91
- continue button not working 91
- continue button unavailable 91
- copier or scanner does not respond 85
- copies
 - making 45
- copy and scan troubleshooting
 - cannot scan to computer over a network 86
 - copier or scanner does not respond 85
 - partial document or photo scans 85
 - poor scanned image quality 85
 - scan not successful 86
 - scanning takes too long or freezes the computer 86
- copy job
 - canceling 49
- copy quality, adjusting 46
- copy troubleshooting
 - scanner unit does not close 85
- copying 45
 - adjusting quality 46
 - collating copies 47
 - enlarging an image 46
 - making a copy lighter or darker 47
 - multiple page images on one sheet 48
 - on both sides of the paper 48
 - Pages per Sheet 48
 - photos 46
 - reducing an image 46
 - repeating an image 48
 - tips 45
- custom-size paper
 - printing on 33

D

- default printer, setting 43
- defaults
 - resetting factory defaults 21
- disabling settings timeout 19
- documents
 - loading on scanner glass 29
 - printing 30
 - scanning for editing 52
 - scanning using the printer control panel 50
- duplex
 - copying, manual 48
 - printing, manual 33

E

- Eco-Mode
 - using 21
- energy
 - conserving 8
- enlarging an image 46
- envelopes 27
 - loading 32
 - printing 32
- error using memory card 86
- Ethernet 70
- exterior of the printer
 - cleaning 74
- e-mailing
 - scanned documents 53

F

- factory default settings
 - resetting internal wireless print server 89
 - resetting to 21
- file types
 - supported 36
- finding
 - information 9
 - MAC address 71
 - publications 9
 - Web site 9
- firewall on computer 92
- flash drive
 - inserting 35
 - printing documents from 31
 - printing photos using the proof sheet 39
 - scanning to 51
- France
 - special wireless setup instructions 58
- FreeBox 58

G

- greeting cards 28

H

- heavyweight matte paper 27

I

- improving scan quality 53
- incorrect language appears on display 77

- index cards 28
- information
 - finding 9
- information needed for setting up printer on wireless network 56
- infrastructure network 67
- ink
 - conserving 8
- ink cartridges
 - ordering 14
 - replacing 13
- ink levels
 - checking 73
- inserting a memory card or flash drive 35
- installation
 - cable 66, 67
- installing
 - network printer 72
- installing printer
 - on wireless network (Windows) 57
- installing printer software 25
- installing wireless printer
 - additional computers 57
- interference
 - wireless network 69
- internal wireless print server
 - resetting to factory default settings 89
- IP address 71, 72
 - configuring 58
- IP address, assigning 72
- iron-on transfers 28

J

- jams and misfeeds troubleshooting
 - paper jam in the paper support 82
 - paper jam in the printer 81
 - paper or specialty media 82

K

- key index 72

L

- labels 27
 - printing 33
- language
 - changing 77
- LiveBox 58

- loading

- documents on scanner glass 29
 - envelopes 32
- loading paper 26
- locating
 - SSID 64
 - WEP key 64
 - WPA passphrase 64

M

- MAC address 70
 - finding 71
- MAC address filtering 70
- memory card
 - inserting 35
 - printing documents from 31
 - printing photos using the proof sheet 39
 - scanning to 51
 - supported types 36
- memory card cannot be inserted 86
- memory card slots 11
- memory card troubleshooting
 - cannot print from a flash drive 87
 - checklist 86
 - nothing happens when memory card is inserted 87
- menus
 - diagram of 18
- menus list 18
- minimum system requirements 23
- multiple WEP keys 72

N

- N9UF Box 58
- network connection
 - with USB 70
- network overview 64
- network printer
 - installing 72
- network security 65
- network setup page
 - printing 56
- networking
 - finding IP address of computer 72
 - finding IP address of printer 72
 - IP addresses 72
- no wireless network 59

nothing happens when memory card is inserted 87

P

page does not print 79

Pages per Sheet copies 48

paper

conserving 8

paper and media

banner paper 27

envelopes 27

heavyweight matte paper 27

index cards 28

iron-on transfers 28

photo cards 28

photo/glossy paper 28

plain paper 26

postcards 28

transparencies 28

paper default settings

saving 28

paper exit tray 11

paper feed guard 11

paper guides 11

paper jam in the paper support 82

paper jam in the printer 81

paper or specialty media

misfeeds 82

paper support 11

partial document or photo

scans 85

parts

memory card slots 11

paper exit tray 11

paper feed guard 11

paper guides 11

paper support 11

PictBridge port 11

power supply port 12

printer control panel 11

printhead 12

scanner glass 12

scanner unit 12

security slot 12

top cover 11

USB port 12

password 65

pausing

print job 44

PDF

creating from scan 53

photo cards 28

photo/glossy paper 28

photos

copying photos 46

making borderless copies 46

printing from digital camera using

DPOF 40

printing using printer control

panel 36

printing using the proof sheet 39

scanning for editing 51

photos do not print from memory

card across wireless network 87

photos from memory device

printing using printer

software 37

PictBridge port 11

PictBridge-enabled camera

connecting 38

plain paper 26

poor quality at the edges of

page 83

poor scanned image quality 85

postcards 28

Power Saver timeout

changing 20

power supply port 12

print job

canceling 44

pausing 44

resuming 44

print media

greeting cards 28

labels 27

print speed is slow 84

print troubleshooting

cannot delete documents from

print queue 81

computer slows down when

printing 84

poor quality at the edges of

page 83

slow print speed 84

streaks or lines on printed

image 83

printer

sharing 62

sharing in Windows 62

printer control panel 11

using 16

printer does not print

wireless 92

printer does not print wirelessly 93

printer does not respond 80

printer menus 18

printer printing blank pages 80

printer problems, basic

solutions 76

printer software

installing 25

uninstalling 25

printer, setting as default 43

printhead 12

aligning 73

printhead error 77

printhead nozzles

cleaning 74

printing

collate 30

custom-size paper 33

documents 30

documents from memory card or

flash drive 31

envelopes 32

from a Bluetooth-enabled

device 42

from a PictBridge-enabled

camera 38

labels 33

last page first 31

multiple pages on one sheet 31

network setup page 56

on both sides of the paper 33

photos from digital camera using

DPOF 40

photos from memory device using

printer software 37

photos using printer control

panel 36

photos using the proof sheet 39

reverse page order 31

tips 30

two-sided 33

printing in draft mode 43

printing mode

changing 43

proof sheet

using 39

protocol 72

publications

finding 9

R

recycling 8

Dell products 15

- reducing an image 46
- repeating an image 48
- replacing ink cartridges 13
- resetting
 - internal wireless print server to factory default settings 89
- resetting to factory defaults 21
- resuming
 - print job 44
- reverse page order 31

S

- safety information 7
- saving paper default settings 28
- scan
 - black and white 53
 - improving quality 53
 - PIN 54
- scan job
 - canceling 54
- scan was not successful 86
- scanner glass 12
 - cleaning 75
- scanner unit 12
- scanner unit does not close 85
- scanning
 - creating a PDF from scan 53
 - documents for editing 52
 - documents for e-mailing 53
 - photos for editing 51
 - tips 50
 - to a computer 50
 - to a flash drive 51
 - to a memory card 51
 - to a network 50
 - using the printer control panel 50
- scanning takes too long or freezes the computer 86
- security
 - wireless network 55
- security information
 - wireless network 65
- security key 65
- selecting the wireless port 98
- Service Center 76
- setting up printer
 - on wireless network (Windows) 57
- settings timeout
 - disabling 19

- setup troubleshooting
 - cannot print through USB 81
 - incorrect language appears on display 77
 - page does not print 79
 - printer does not respond 80
 - printer printing blank pages 80
 - printhead error 77
 - software did not install 78
- sharing printer in Windows 62
- software
 - Service Center 76
- software did not install 78
- software updates
 - checking 25
 - enabling 25
- SSID
 - ad hoc 59
 - finding 70
 - locating 64
 - wireless network 64
- streaks or lines on printed image 83
- supported memory cards and file types 36
- supported operating systems 23
- switching from USB
 - to wireless 62
- switching from wireless
 - to USB 62

T

- TCP/IP 72
- technical support 76
- temporary settings
 - changing into default 19
- tips for
 - copying 45
 - printing 30
 - scanning 50
- top cover 11
- transparencies 28
- troubleshooting
 - checking an unresponsive printer 76
 - contacting technical support 76
 - Service Center 76
 - solving basic printer problems 76
 - wireless network 88
- troubleshooting, copy
 - scanner unit does not close 85

- troubleshooting, copy and scan
 - cannot scan to computer over a network 86
 - copier or scanner does not respond 85
 - partial document or photo scans 85
 - poor scanned image quality 85
 - scan not successful 86
 - scanning takes too long or freezes the computer 86
- troubleshooting, jams and misfeeds
 - paper jam in the paper support 82
 - paper jam in the printer 81
 - paper or specialty media 82
- troubleshooting, memory card
 - cannot print from a flash drive 87
 - checklist 86
 - nothing happens when memory card is inserted 87
- troubleshooting, print
 - cannot delete documents from print queue 81
 - computer slows down when printing 84
 - poor quality at the edges of page 83
 - slow print speed 84
 - streaks or lines on printed image 83
- troubleshooting, setup
 - cannot print through USB 81
 - incorrect language appears on display 77
 - page does not print 79
 - printer does not respond 80
 - printer printing blank pages 80
 - printhead error 77
 - software did not install 78
- troubleshooting, wireless
 - cannot print over wireless network 89
 - changing wireless settings after installation (Windows) 59
 - photos do not print from memory card across wireless network 87
 - resolving communication problems 100
 - Wi-Fi indicator light is blinking orange 95

- Wi-Fi indicator light is not lit 93
- Wi-Fi indicator light is still orange 94

U

UK

- special wireless setup instructions 58
- uninstalling printer software 25
- updating printer software 25
- updating the application list 54
- USB 62, 70
 - cable 67
- USB connection
 - with network connection 70
- USB port 12

V

- Virtual Private Network 100
- VPN
 - lose connection to printer 100

W

- Web site
 - finding 9
- WEP 55
 - ad hoc 59
- WEP key
 - key index 72
 - locating 64
- Windows
 - installing printer on wireless network 57
- Windows software
 - Abbyy Sprint OCR 23
 - Fast Pics 23
 - Fax Setup Utility 23
 - Fax Solutions software 23
 - Printer Home 23
 - Printing Preferences 23
 - Service Center 23
 - Toolbar 23
 - Wireless Setup Utility 23
- wireless 62, 70
 - printer does not print 92
 - troubleshooting 93, 100
- wireless network
 - adding a printer to existing ad hoc network 61
 - common home configurations 65

- creating an ad hoc network using Windows 59
- information needed for setting up wireless printing 56
- installing printer on (Windows) 57
- interference 69
- resolving communication problems 100
- security 55
- security information 65
- signal strength 68
- SSID 64
- troubleshooting 88
- types of wireless networks 67
- wireless network compatibility 55
- wireless print server
 - not installed 98
- wireless setup
 - information needed for 56
- wireless signal strength 68
- wireless signal absorption 69
- wireless troubleshooting
 - cannot print over wireless network 89
 - changing wireless settings after installation (Windows) 59
 - photos do not print from memory card across wireless network 87
 - printer and computer on different networks 70
 - printer works intermittently on wireless network 100
- Wi-Fi indicator light is blinking orange 95
- Wi-Fi indicator light is not lit 93
- Wi-Fi indicator light is still orange 94
- Wi-Fi indicator
 - description of colors 57
 - light is not lit 93
- Wi-Fi indicator light is blinking orange 95
- Wi-Fi indicator light is green
 - printer does not print 93
- Wi-Fi indicator light is still orange 94
- Wi-Fi Protected Setup 62
 - using 63
- Wi-Fi Protected Setup logo
 - identifying 63

- WPA 55
- WPA passphrase
 - locating 64
- WPA2 55
- WPS 62